

IMPLANT SURGERY

NARHAM
EXCELLENCE IN INSTRUMENTATION



RECOVERY OF TOOTH FRAGMENTS THROUGH SURGERY

In the last decade, implantology has become an important part of clinical practice, helping dentists improve the quality of life of their patients. While implants might often be a convenient alternative to conventional treatment options, in certain cases, it is mandatory for the rehabilitation of functional, anatomical or aesthetic problems arising from tooth loss.

SS Dental has developed a number of highly functional and easy-to-use instruments to help

qualified dentists tackle even the most challenging clinical cases and to effectively and fully deliver all the advantages of implant surgery, including a high degree of stability, the preservation of bone in the alveolar process, and long-term results. Our proficiency with design and manufacturing has led to educational collaboration with major dental institutions to grow competency in this branch among dental professionals.

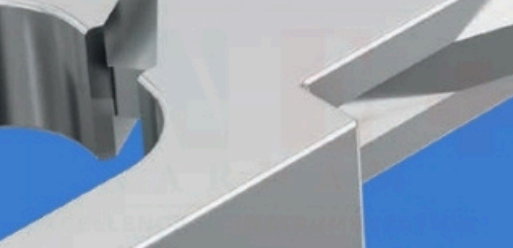

HANDLE

SINGLE-ENDED

- SS60
(stainless steel)
ø 6.0 mm
- Leonardo ML
(stainless steel)
ø 7.0 mm
- Perfection
(stainless steel)
ø 8.0 mm
- SSWave RC
(plastic resin in PPSU
with a steel core)
ø 7.5 / 14.5 mm

DOUBLE-ENDED 60

- (stainless steel)
ø 6.0 mm
- SS Light MV
(stainless steel,
hollow)
ø 8.0 mm Leonardo
- ML
(stainless steel)
ø 7.0 mm Perfection
(stainless steel)
ø 8.0 mm Octagonal
(stainless steel)
ø 5.5 mm
- SSWave RC
(plastic resin in PPSU
with a steel core)
ø 7.5 / 14.5 mm



standard instrument



instrument with tungsten carbide (TC) inserts

HOW TO USE THE INFORMATION

- CP-12 — model + scientific
- RC0702-12 — name SS Dental code
- SSWave RC — handle option

SSLady

products ergonomically designed for women's hands:

- smaller and lighter handles
- smaller finger holes
- reduced size

code starts with "W" or "SW"



these products are not manufactured by SS Dental and are distributed with the manufacturer's brand



top view



side view

GUM SCISSORS

Dissecting scissors

NEEDLE HOLDERS



1 Goldman-Fox
straight
one serrated blade
13 cm
0304-1



2 Goldman-Fox
curved
one serrated blade
13 cm
0304-2



1 Metzenbaum-Delikat
straight
14.5 cm
0322-1



1TC Kelly
straight
16 cm
0309-1TC



2TC Kelly
curved
16 cm
0309-2TC



2 Metzenbaum-Delikat
curved
14.5 cm
0322-2



TC Mathieu
14 cm
0435-14TC



TC Mathieu
17 cm
0435-17TC



TC Castroviejo
14 cm
0445TH-14TC



TC Castroviejo
14 cm
0446TH-14TC



TC Lichtenberg
17 cm
0437-17TC



TC Castroviejo
14 cm / 60°
0448TH-14TC

NEEDLE HOLDERS

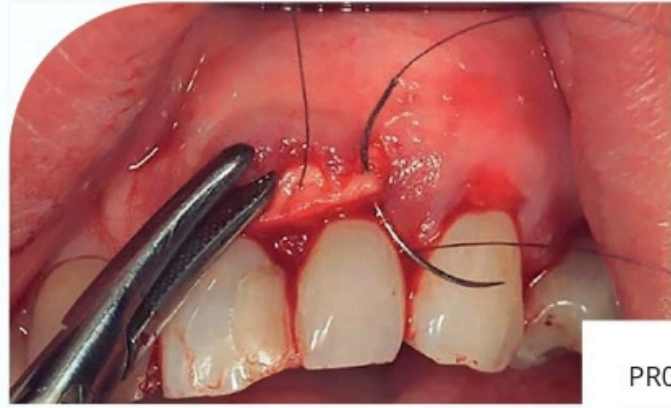

PR0460-15TC
Curved Castroviejo needle holder.
Facilitates suturing.



TC Castroviejo
with curved jaws
15.5 cm
PR0460-15TC



TC Micro-Barraquer
18 cm
0450TH-18TC



TC Micro-Barraquer
with curved jaws
18 cm
0451TH-18TC

SCALPEL HANDLES



3
13 cm
0350-3



3
12 cm
W0349-3



3G
13 cm
0350-3G



8
13 cm
0350-8



7
16 cm
0350-7

SCALPEL HANDLES

SCALPEL BLADES 
100 pcs (sterile) / box

MICRO -BL ADES 
25 pcs (sterile) / box

ORIENTABLE BLADE
SCALPEL HANDLES

BLADE
REMOVER



5
14.5 cm
0350-5

5A
14.5 cm
0350-5A

10
0351-10

11
0351-11

12
0351-12

12D
double
cutting edge
0351-12D

15
0351-15

15C
0351-15C

13.5
cm
0365-1

4
0366-4

7
0366-7

16 cm
0335-1
(pair of instruments)

16.5 cm
0352

S0352
kit of
0352
blade remover +
0335-1
(pair of instruments)
orientable blade scalpel
handles

DISPOSABLE SCALPELS
10 pcs / box

RETRACTORS
Lip retractor

Openable vestibular retractor

RETRACTORS

Lip retractors



0371-11



0371-12

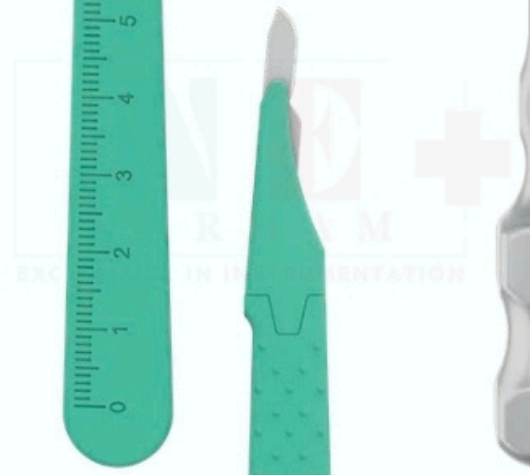

0371-10

0371-15



24 cm
2628-1



19 cm
2628-2



20 cm
2627



Sternberg
14 cm
2 6 02-1



Orringer medium
11 x 8 cm
2609-2

RETRACTORS
Cheek retractor



14x17 mm

University of Minnesota
14 cm
2604

Middeldorpf
21.5 cm
2620-1



72x11 mm

35x11 mm

21 cm
2625-1

21 cm
2626-1



1
MV1856-1
Asa Light MV



2
MV1856-2
Asa Light MV



3
MV1856-3
Asa Light MV



4
MV1856-4
Asa Light MV

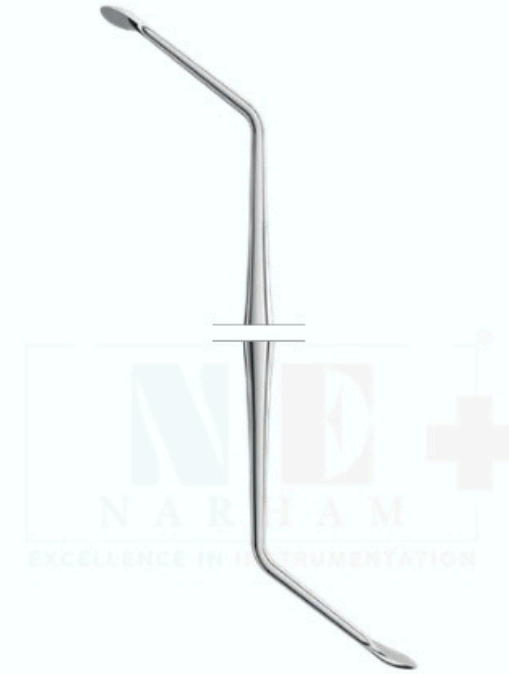

5
MV1856-5
Asa Light MV

SINUS LIFT INSTRUMENTS



SINUS LIFT INSTRUMENTS

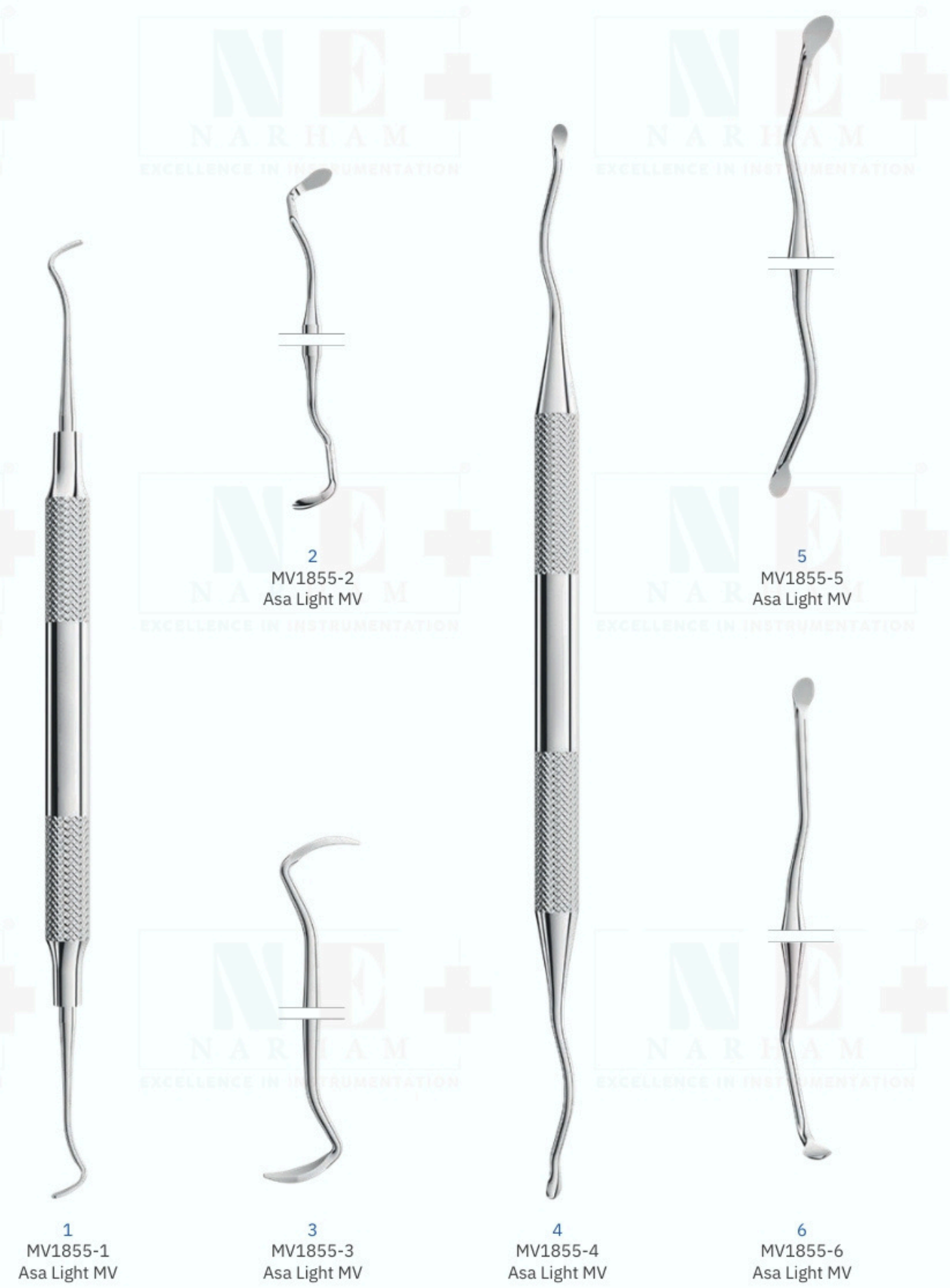

SURGICAL MALLET

FREER SINGLE CUT CHISELS

GRADUATED CHISELS



Partsch
18 cm
1880
lead filled

Mead
19.5 cm
1881



1 Freer
1839-1



3 Freer
1839-3

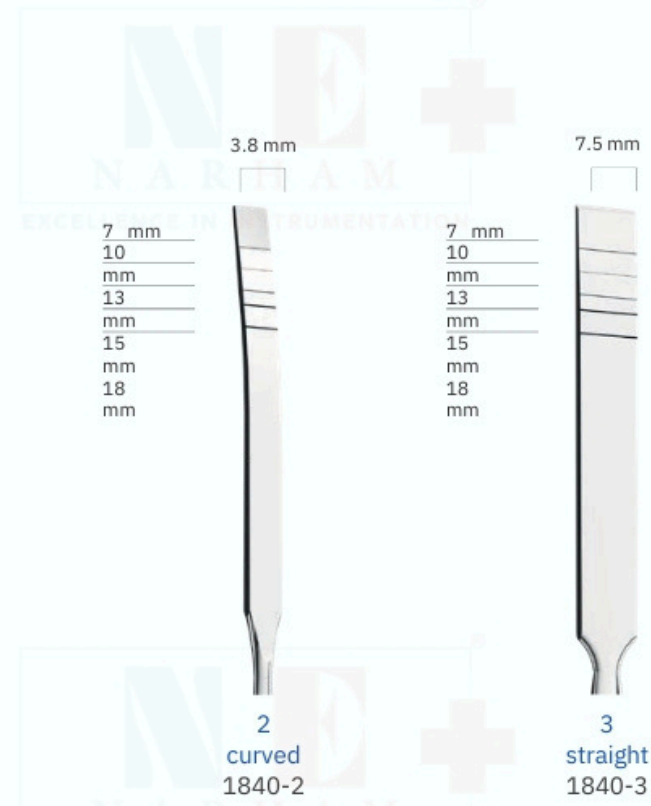

1840-1

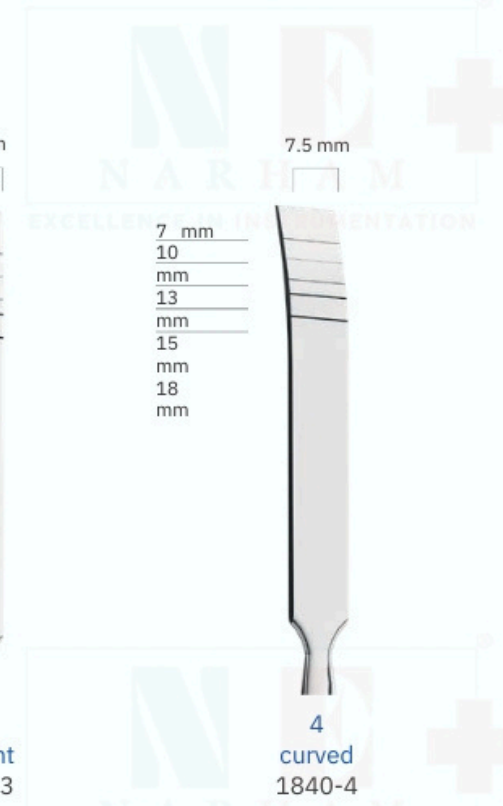
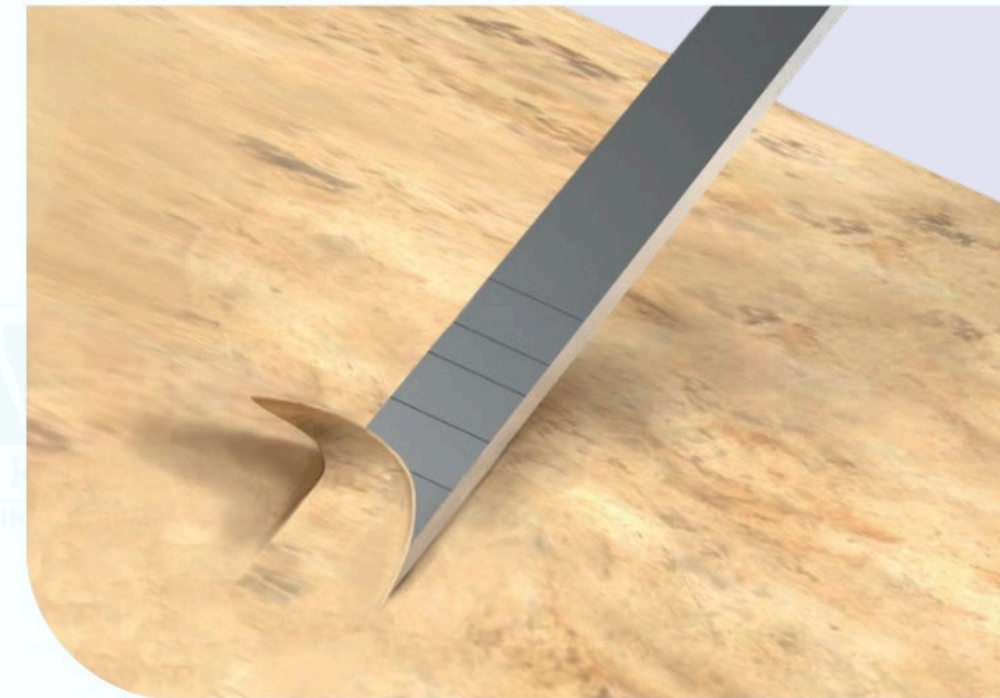

OSTEOTOMES

annular osteotomes with setting point

CONC AVE	CONC AVE	CONCAVE	CONCAVE	ANGULAR	FLAT
Ø 3 mm	Ø 3.3 mm	Ø 3 mm	Ø 3.3 mm	Ø 3 mm	Ø 3 mm
6 mm 8 mm 10 mm 12 mm 15 mm	6 mm 8 mm 10 mm 12 mm 15 mm	6 mm 8 mm 10 mm 12 mm 15 mm	165 mm 0498-2C33	165 mm 0498-30B3	120 mm 0498-PF3
165 mm 0498-1B3	165 mm 0498-1B5	165 mm 0498-2C3	165 mm 0498-2C4	165 mm 0498-30B4	120 mm 0498-PF4
165 mm 0498-1B3	165 mm 0498-1B5	165 mm 0498-2C3	165 mm 0498-2C5	165 mm 0498-30B5	120 mm 0498-PF5

OSTEOTOMES

1 · 2 · 3 · 4 · 5 · 6
S0495-6
set of 6
with tray
S2702

CONCAVE	CONCAVE	CONCAVE	CONCAVE	CONCAVE	CONCAVE
Ø 1.5 mm	Ø 1.8 mm	Ø 2.9 mm	Ø 3.1 mm	Ø 4.1 mm	Ø 5.5 mm
7.5 9 10 5 12 13 2 15 2	7.5 9 10 5 12 13 2 15 2	7.5 9 10 5 12 13 2 15 2	7.5 9 10 5 12 13 2 15 2	8.5 10 11	8.5 10 11
1.6 1.7 2.2 2.4 2.5 3.4	2 2.1 2.9 3 3.1 3.2	3.1 3.2 3.3 3.4 3.4 3.5	3.8 3.9 4.1 4.2 4.3 4.6	5 5 5	6 6 6 2 6 2
155 mm 0495-1	155 mm 0495-2	155 mm 0495-3	155 mm 0495-4	155 mm 0495-5	155 mm 0495-6

OSTEOTOMES

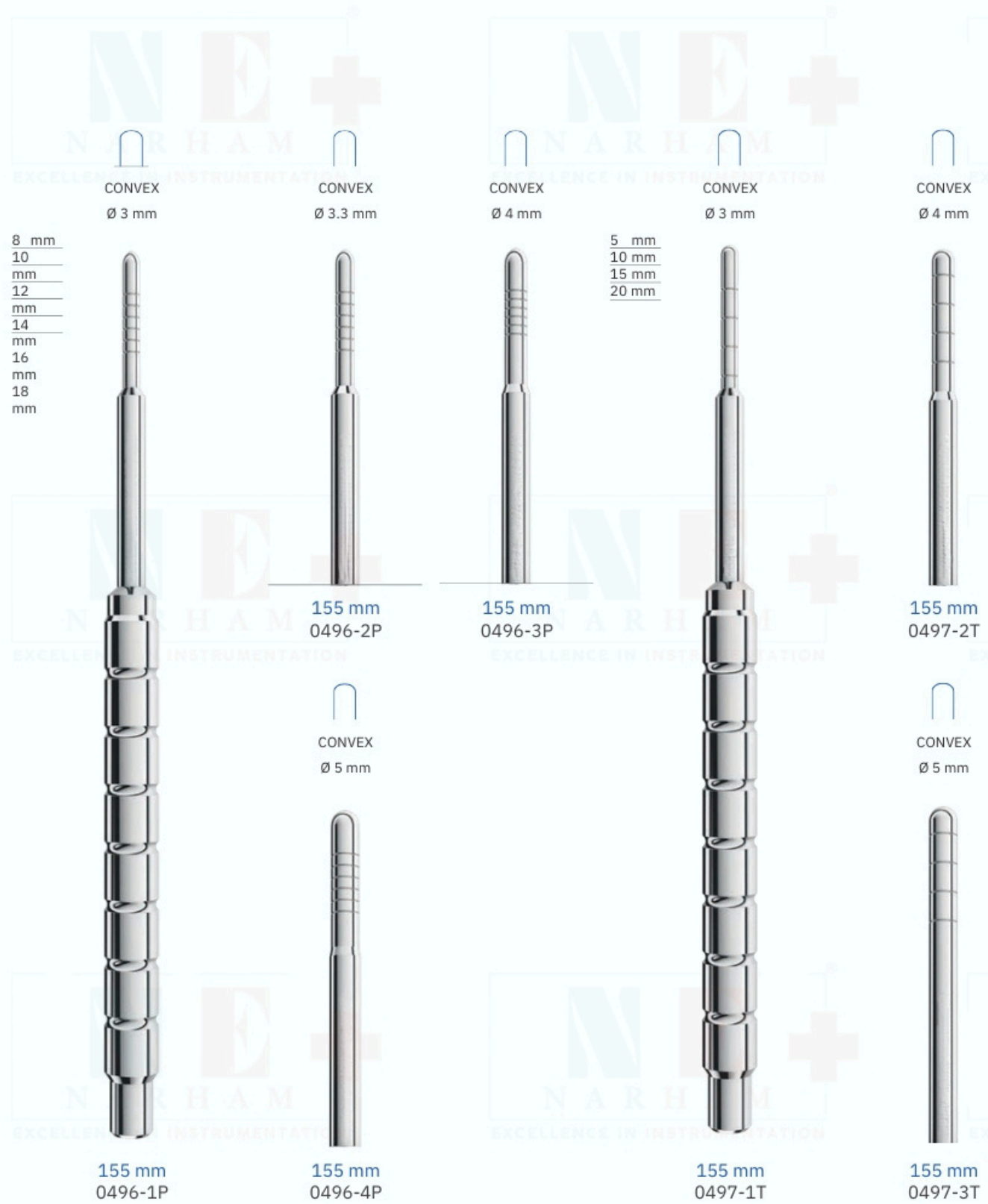

BONE FILES



BONE CURETTES



E XCISER

PERIOSTEAL ELEVATORS

PERIOSTEAL ELEVATORS



1
PR1857-1
Perfection



3 mm
LANCE TIP
Buser
PR1850-M
Perfection



Beale
5114-1
Octagonal



GF Goldman-Fox
MV1850-GF
Asa Light MV



9A Allen
MV1850-9A
Asa Light MV



M7 Molt
MV1850-M7
Asa Light MV



M8 Molt
MV1850-M8
Asa Light MV



M9 Molt
MV1850-M9
Asa Light MV



2 Hourigan
MV1851-2
Asa Light MV



PR3 Prichard
MV1851-PR3
Asa Light MV

PR1850-M

Periosteal elevator with a rounded tip and a lance tip

Allows efficient release of even the narrowest and scalloped gingival margins.



PERIOSTEAL ELEVATORS

PR1850-1
PERIOSTEAL ELEVATOR

For atraumatic release and lifting of the papilla in papilla preservation techniques.



Partsch
14.5 cm
1849-1
Asa60



3 Mead
MV1854-3
Asa Light MV

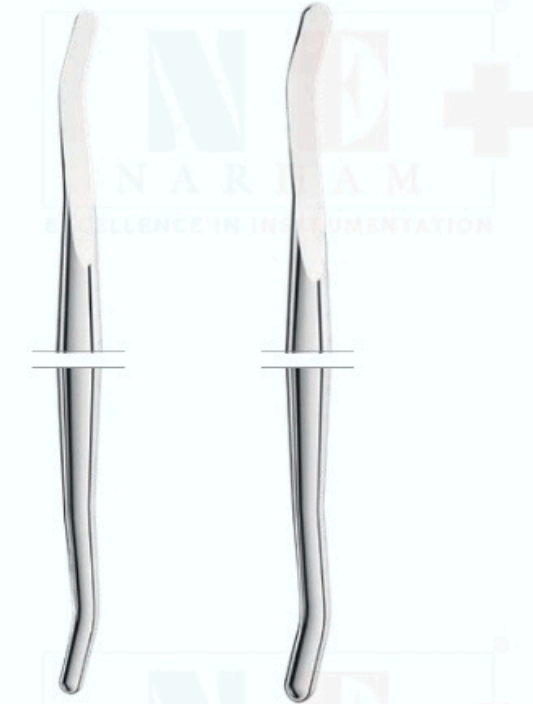

1 Hopkins
MV1852-1
Asa Light MV

2 Hopkins
MV1852-2
Asa Light MV



15 Freer
MV1853-15
Asa Light MV

16 Freer
MV1853-16
Asa Light MV

2 mm



2.5 mm
17 cm
PR1850-1
Perfection

PERIOSTEAL ELEVATORS



22 Seldin
retractor
1855-22



23 Seldin
retractor
1855-23



König
15.5 cm
1858-1



Williger
17 cm
1856-1



Williger
16 cm
1856-2



Williger
16 cm
1857-1



Williger
13 cm
1857-2

MUCOTOMES

3 mm



straight
1844-3

3 mm

4 mm



straight
1844-4

4 mm

5 mm



straight
1844-5

5 mm

6 mm



straight
1844-6

6 mm



curved
1844-3C



curved
1844-4C



curved
1844-5C



curved
1844-6C

BONE INJECTOR

Ø 2.5 mm



16 cm
0490-1

Ø 4.5 mm



16 cm
0490-2

BONE MILL



17 cm
1846

BONE SCRAPERS



straight
15 cm
0494-1
blade included

straight
0494-1R
blade for
0494-1

curved
15 cm
0494-2
blade included

straight
0494-2R
blade for
0494-2

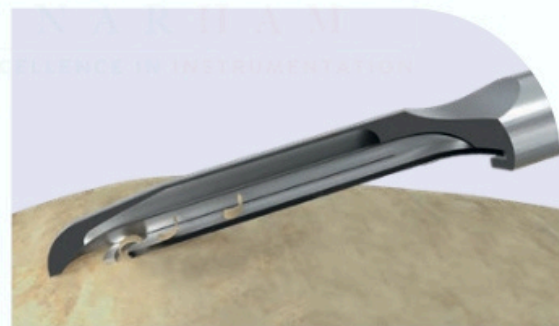
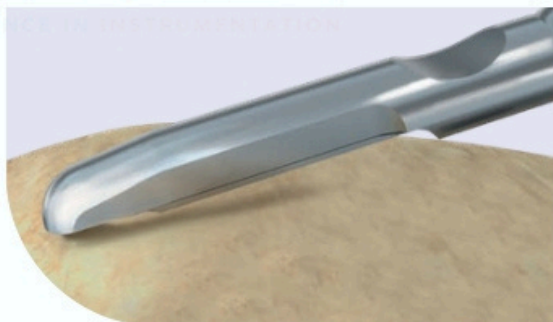

0494-1

PERIOTOMES



1
ML1845-1
Leonardo ML

2
ML1845-2
Leonardo ML

3
ML1845-3
Leonardo ML

MV1231-1
Asa Light MV

BONE/SOFT TISSUE NIPPER



Goldman-Fox
10 cm
0103-60

small size for use
in limited access areas

BONE RONGEURS



Luer
14.5 cm
0103-10



Mini Friedman
12 cm
0103-25

45°



Blumenthal
14 cm
0103-31



Blumenthal
15 cm
0103-30

BONE THICKNESS GAUGES



0491-2



17.5 cm
0491-1



15.5 cm
0491-2

MEMBRANE PLACEMENT INSTRUMENT



Buser
MV1883
Asa Light MV

BONE WELL



POCKET PROBES



DEPTH GAUGE



SALIVAEJECTORS
Bone filters



C ALIPER



BUR HOLDERS

Aluminum, suitable for steam sterilizing

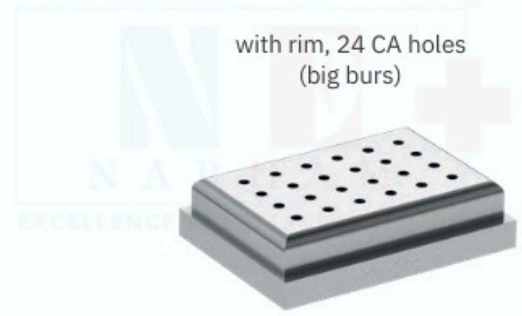

with rim, 24 CA holes
(big burs)

AL2760-2

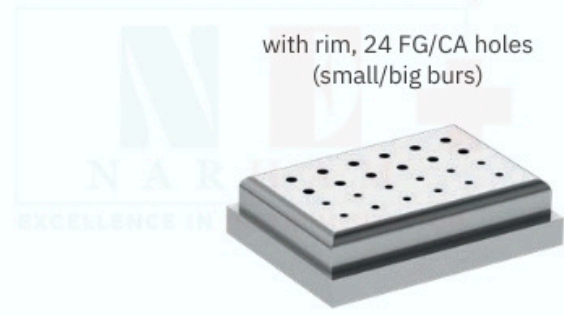

with rim, 24 FG/CA holes
(small/big burs)

AL2760-3

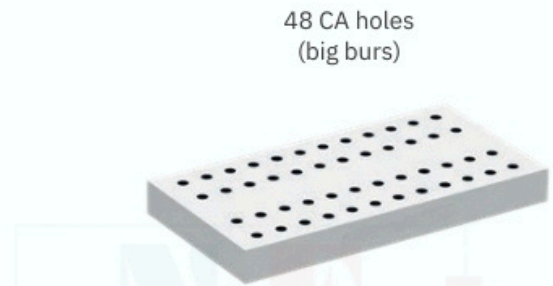

48 CA holes
(big burs)

AL2762-2

Colored silicone with a plastic cover

lid
non autoclavable



AL2761-U

autoclavable
non-toxic food silicon

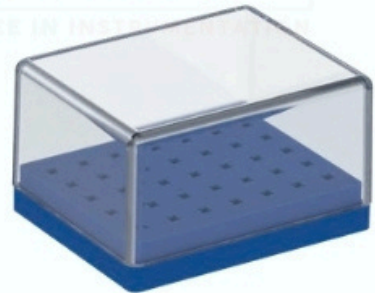

Blue
S2760-C



autoclavable
atoxic food silicon

Orange
S2760-A

BONE COMPACTORS



1
MV1230-1



2
MV1230-2

PERIODONTAL POCKET MARKERS



1 (Crane-Kaplan)
Goldman-Fox
15 cm
0650-1



2 (Crane-Kaplan)
Goldman-Fox
15 cm
0650-2



TISSUE PLIERS

TISSUE PLIERS
suture pliers

MEMBRANE HOLDING TWEEZERS

IMPLANT HOLDING TWEEZERS



1 Adson 12 cm 0620-1
 1 Adson 1x2 12 cm 0621-1
 1 Semken-Taylor 12.5 cm 0630-1
 2 Semken-Taylor 12.5 cm 0630-2



0.16 mm
 16 cm PR0625-2
 0.13 mm
 17 cm PR0625-3



10.5 cm 0660-1



9 cm 0660-2 with ring tips



16.5 cm 0661-1



14.5 cm 0661-2
 14.5 cm 0661-3

INSTRUMENT KIT FOR IMPLANT SURGERY

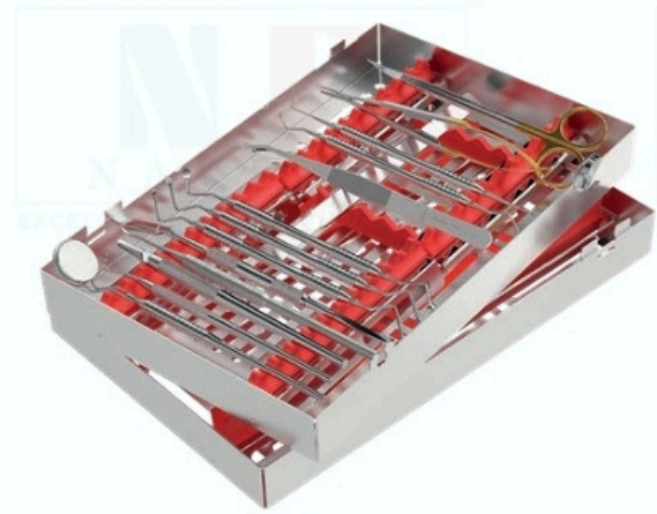

Implant surgery kit
SPR2781-I

ML2101	mouth mirror handle	
2230-5	double sided mouth mirrors	5
07 02 L-1 5	periodontal pocket probes	CP-15
0350-5	scalpel handle and blade	5
PR1857-1	exciser Prichard periosteal	
MV1851-PR3	Seldin retractor Lucas bone	PR3
1855-23	curette Lucas bone curette	23
ML2001-85	Lucas bone curette tissue	85
ML2001-87	pliers periodontal	87
ML2001-88	instrument periodontal	88
PR0625-2	instrument Castroviejo	
ML1806-2RL	needle holder gum scissors	2R /
ML1806-4RL	instrument cassette	2L
PR0460-15TC		4R/4L
0309-2TC		2TC
2780-1R		

INSTRUMENT KIT FOR IMPLANT SURGERY

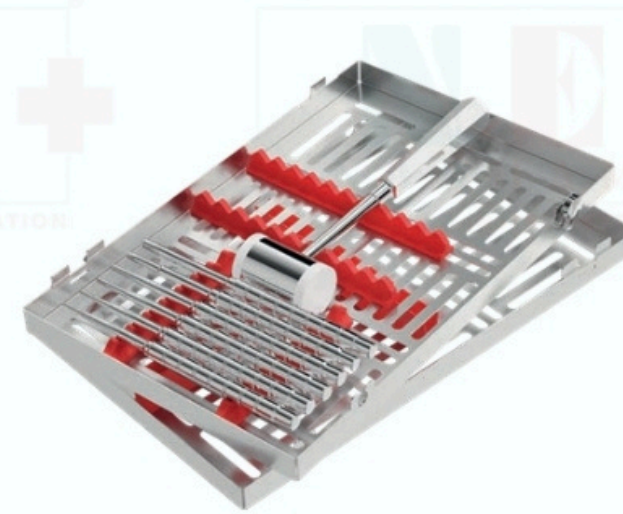

Mini sinus lift kit
SPR0495

0495-1	osteotomes	
0495-2	osteotomes	
0495-3	osteotomes	
0495-4	osteotomes	
0495-5	osteotomes	
0495-6	osteotomes mead	
1881	mallet instrument	
2770-1R	cassette	



Maxi sinus lift kit
SPR0496

PR1859-1	maxillary sinus instrument	
PR1859-2	maxillary sinus instrument	
MV1231-1	bone injector	
0490-1	bone injector	
MV1856-2	maxillary sinus instrument	2
2770-3R	instrument cassette	

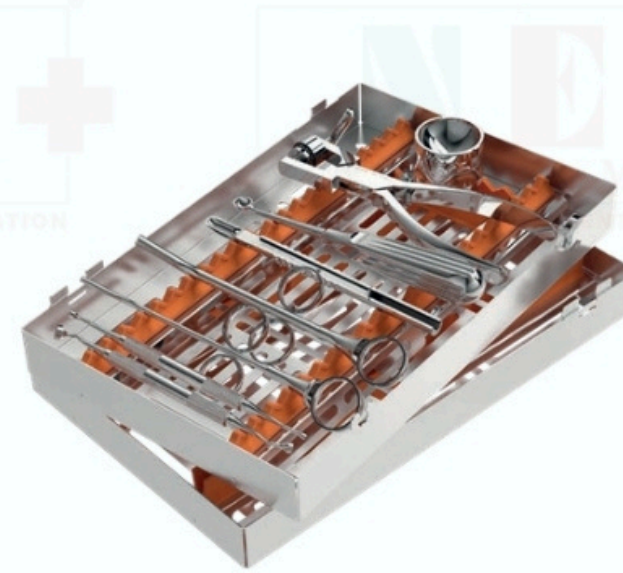

288 x 182 x h. 60 mm
S2780-IMP

1030-4	bone well	
1846	bone mill	
2014-3	bone curettes	3
0494-1	straight bone scraper	
0490-2	bone injector	
0490-1	bone injector	
MV1230-1	bone compactor	1
MV1230-2	bone compactor	2
2780-1A	instrument cassette	



INSTRUMENT KIT FOR IMPLANT SURGERY



Mini sinus lift kit
S0498-8

0498-1B4	concave osteotome concave	1B4
0498-2C4	osteotome angular	2C4
0498-30B4	osteotome flat osteotome	30B4
0498-PF4	Towner-Jacquette scaler	PF4
1 9 02-2	Goldman-Fox Universal scaler	U15/30
1809-1	Jacquette curette Lucas bone	1
1831-32	curette perforated instrument	31/ 32
2001-87	tray complete with insert	87
S2702	frame	



kit Goracci
S3001-20

0300-1	gum scissors, straight	
0601-1	Flagg cotton & dressing pliers	
0704-23D2	explorer d. e.	23/17A
0903-2	cement spatula, double-ended	2
1101-2	Heidemann separating spatulas	2
1200-2	double-ended filling instruments	2
1202-1L	double-ended filling instruments	1L
1202-2L	double-ended filling instruments	2L
1211-1T	Tanner filling instrument placement instrument	1T
1301	Hollenback amalgam covers	1/2
1500-02	cleoid- discoïd	1
1600-1	gingival margin trimmer	26
1601-1	gingival margin trimmer	27
1601-2	double-ended excavator	1
170 0 -1	double-ended excavator	2
1700-2	double-ended excavator	3
1700-3	double-ended excavator	4
1700-4	mirror handle	
2102-IN	mouth mirror plane	5
2200-5	instrument tray with a perforated base and insert frame	
S2721-2		

INSTRUMENT KIT FOR IMPLANT SURGERY

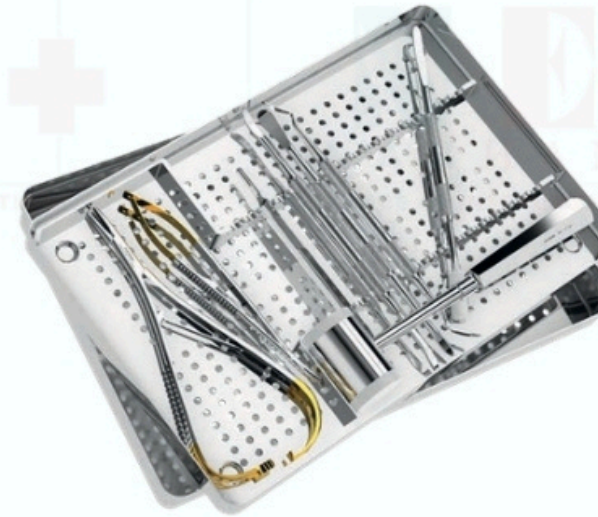

S3003-9

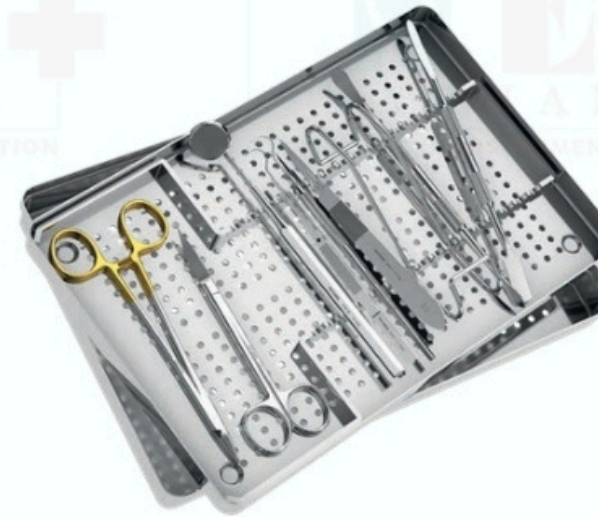

S3003-11

MV1850-M9	Molt periosteal Prichard	M9
MV1851-PR3	periosteal Goldman-Fox	PR3
MV1850-GF	periosteal Kirkland knife	GF
MV1803-D	Mead mallet Castroviejo	15K/16K
1881	needle holder Mathieu	
0446TH-14TC	needle holder scalpel	
0435-17TC	handle perforated	
0350-3	instrument tray complete with insert frame	3
S2722-1		

0350-3	scalpel handle	3
2 6 02-1	Sternberg retractor	
0304-2	Goldman-Fox scissors	2
MV1850-M9	Molt periosteal	M9
MV1851-PR3	Prichard periosteal	PR3
0415-15TC	Crile-Wood needle holder	
0631-1	Semken Taylor tissue plier	1
0700-23	explorer with an anatomic handle	23
2102-IN	mouth mirror handle	
2200-5	mouth mirror plane	5
0351-11	scalpel blades (100 pcs)	11
S2722-1	perforated instrument tray complete with insert frame	