

# LAPAROSCOPIC CATALOGUE

## MARYLAND Dissecting Forceps, Curved



Ratchet System	Standard Ø5 x 330 mm	Bariatric Ø5 x 450 mm
With Ratchet		
Without Ratchet	LXD-101	LXD-B-101



## METZENBAUM Curved Scissors



Ratchet System	Standard Ø5 x 330 mm	Bariatric Ø5 x 450 mm
With Ratchet		
Without Ratchet	LXD-102	LXD-B-102



## ENDO Clinch Grasping Forceps Fenestrated



Ratchet System	Standard Ø5 x 330 mm	Bariatric Ø5 x 450 mm
With Ratchet	LXD-103R	LXD-B-103R
Without Ratchet	LXD-103	LXD-B-103



## YOHAN Grasping Forceps, Fenestrated



Ratchet System	Standard Ø5 x 330 mm	Bariatric Ø5 x 450 mm
With Ratchet	LXD-104R	LXD-B-104R
Without Ratchet	LXD-104	LXD-B-104



## BABCOCK Grasping Forceps



Ratchet System	Standard Ø5 x 330 mm	Bariatric Ø5 x 450 mm
With Ratchet	LXD-105R	LXD-B-105R
Without Ratchet	LXD-105	LXD-B-105



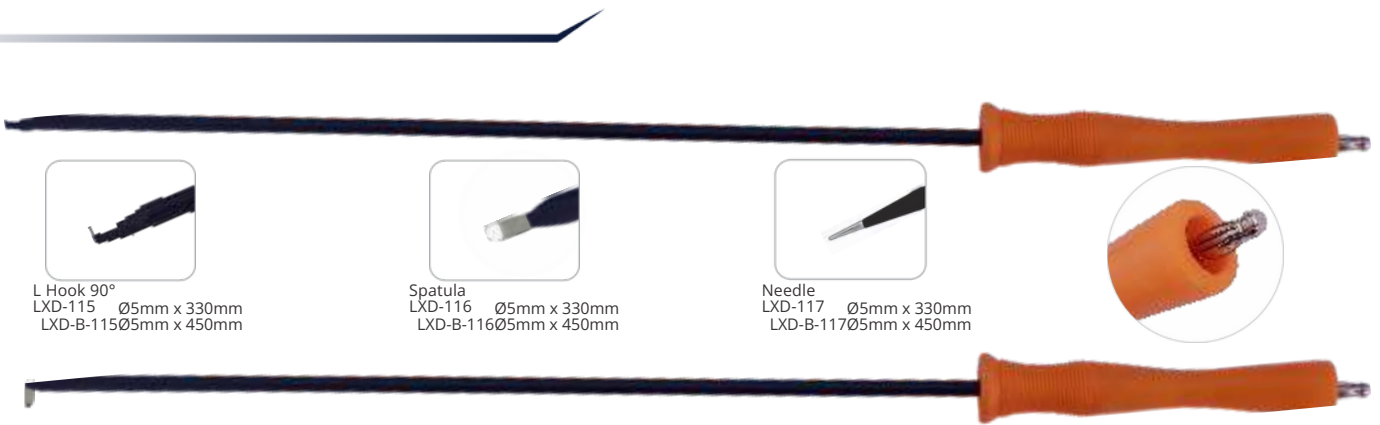

L Hook 90°  
LXD-115 Ø5mm x 330mm  
LXD-B-115Ø5mm x 450mm



Spatula  
LXD-116 Ø5mm x 330mm  
LXD-B-116Ø5mm x 450mm



Needle  
LXD-117 Ø5mm x 330mm  
LXD-B-117Ø5mm x 450mm



## Disposable Camera Sleeve Drape Cover & Endo Bags



LXD-118  
Camera Sleeve/Drape Cover

LXD-119  
Endo Bag with handle  
(300ml)



LXD-120  
Endo Bag Pouch type (200ml)

## Disposable Trocars



Disposable Trocars LXD-121-3  
Ø3.5mm x 80mm LXD-121-5  
Ø5.5mm x 100mm LXD-121-10  
Ø10.5mm x 100mm LXD-121-12  
Ø12.5mm x 100mm



Disposable Trocars Set (LXD-122)  
Contents  
2 x Ø5.5mm Trocars  
2 x Ø10.5mm Trocars  
1 x Veress Needle  
1 x Endo bag



Reusable Click Line Handle

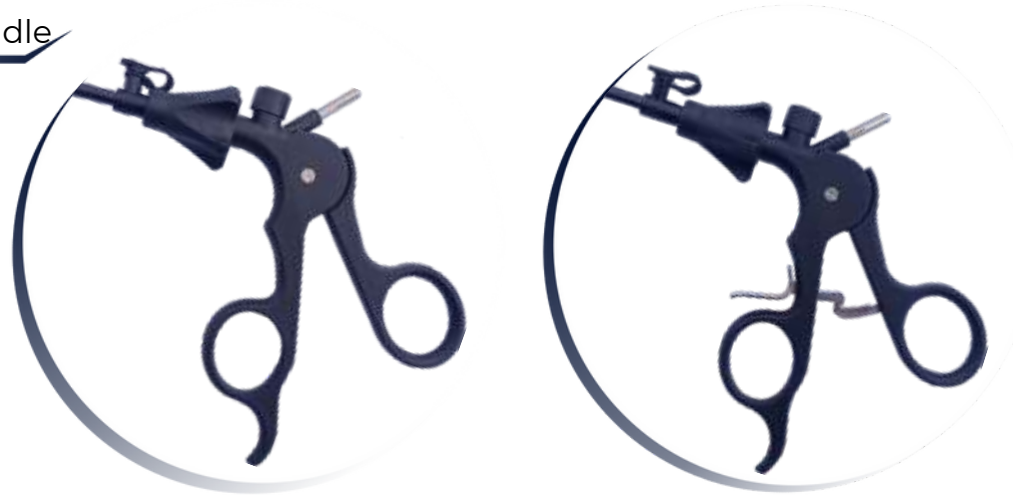

MARYLAND Dissecting Forceps, Curved

	Ratchet System	Pediatric Ø3 x 220 mm	Standard Ø5 x 330 mm	Bariatric Ø5 x 450 mm
	With			
	Without			
	Ratchet	LXP-101	LX-101	LXB-101

MARYLAND Dissecting Forceps, Straight

	Ratchet System	Pediatric Ø3 x 220 mm	Standard Ø5 x 330 mm	Bariatric Ø5 x 450 mm
	With			
	Without			
	Ratchet	LXP-101S	LX-101S	LXB-101S

DOLPHIN Nose Dissecting Forceps

	Ratchet System	Pediatric Ø3 x 220 mm	Standard Ø5 x 330 mm	Bariatric Ø5 x 450 mm
	With			
	Without			
	Ratchet		LX-101N	LXB-101N

Dissecting Forceps, 90° Curved

	Ratchet System	Pediatric Ø3 x 220 mm	Standard Ø5 x 330 mm	Bariatric Ø5 x 450 mm
	With			
	Without			
	Ratchet	LXP-101D	LX-101D	LXB-101D

METZENBAUM Scissors, Curved

	Ratchet System	Pediatric Ø3 x 220 mm	Standard Ø5 x 330 mm	Bariatric Ø5 x 450 mm
	With			
	Without			
	Ratchet	LXP-102	LX-102	LXB-102

METZENBAUM Scissors, Straight

	Ratchet System	Pediatric Ø3 x 220 mm	Standard Ø5 x 330 mm	Bariatric Ø5 x 450 mm
	With			
	Without			
	Ratchet	LXP-102S	LX-102S	LXB-102S

HOOK Scissors

	Ratchet System	Pediatric Ø3 x 220 mm	Standard Ø5 x 330 mm	Bariatric Ø5 x 450 mm
	With			
	Without			
	Ratchet		LX-102H	LXB-102H

ENDO Grasping Forceps, Fenestrated

	Ratchet System	Pediatric Ø3 x 220 mm	Standard Ø5 x 330 mm	Bariatric Ø5 x 450 mm
	With			
	Without			
	Ratchet	LXP-103R	LX-103R	LXB-103R
	Ratchet	LXP-103	LX-103	LXB-103

YOHAN Grasping Forceps, Fenestrated

	Ratchet System	Pediatric Ø3 x 220 mm	Standard Ø5 x 330 mm	Bariatric Ø5 x 450 mm
	With			
	Without			
	Ratchet	LXP-104R	LX-104R	LXB-104R
	Ratchet	LXP-104	LX-104	LXB-104

YOHAN Grasping Forceps, Double Action

	Ratchet System	Pediatric Ø3 x 220 mm	Standard Ø5 x 330 mm	Bariatric Ø5 x 450 mm
	With			
	Without			
	Ratchet	LXP-105R	LX-105R	LXB-105R
	Ratchet	LXP-105	LX-105	LXB-105

YOHAN Grasping Forceps, Single Action

	Ratchet System	Pediatric Ø3 x 220 mm	Standard Ø5 x 330 mm	Bariatric Ø5 x 450 mm
	With			
	Without			
	Ratchet	LXP-106R	LX-106R	LXB-106R
	Ratchet	LXP-106	LX-106	LXB-106

INTESTINAL Grasping Forceps, Fenestrated

	Ratchet System	Pediatric Ø3 x 220 mm	Standard Ø5 x 330 mm	Bariatric Ø5 x 450 mm
	With			
	Without			
	Ratchet	LXP-107R	LX-107R	LXB-107R
	Ratchet	LXP-107	LX-107	LXB-107

YOHAN Grasping Forceps, Single Action

	Ratchet System	Pediatric Ø3 x 220 mm	Standard Ø5 x 330 mm	Bariatric Ø5 x 450 mm
	With			
	Without			
	Ratchet	LXP-108R	LX-108R	LXB-108R
	Ratchet	LXP-108	LX-108	LXB-108

WAVE Grasping Forceps

	Ratchet System	Pediatric Ø3 x 220 mm	Standard Ø5 x 330 mm	Bariatric Ø5 x 450 mm
	With			
	Without			
	Ratchet	LXP-109R	LX-109R	LXB-109R
	Ratchet	LXP-109	LX-109	LXB-109

WAVE Grasping Forceps

	Ratchet System	Pediatric Ø3 x 220 mm	Standard Ø5 x 330 mm	Bariatric Ø5 x 450 mm
	With			
	Without			
	Ratchet	LXP-110R	LX-110R	LXB-110R
	Ratchet	LXP-110	LX-110	LXB-110

WAVE Grasping Forceps

	Ratchet System	Pediatric Ø3 x 220 mm	Standard Ø5 x 330 mm	Bariatric Ø5 x 450 mm
	With			
	Without			
	Ratchet	LXP-111R	LX-111R	LXB-111R
	Ratchet	LXP-111	LX-111	LXB-111

WAVE Grasping Forceps

	Ratchet System	Pediatric Ø3 x 220 mm	Standard Ø5 x 330 mm	Bariatric Ø5 x 450 mm
	With			
	Without			
	Ratchet	LXP-112R	LX-112R	LXB-112R
	Ratchet	LXP-112	LX-112	LXB-112

WAVE Grasping Forceps

	Ratchet System	Pediatric Ø3 x 220 mm	Standard Ø5 x 330 mm	Bariatric Ø5 x 450 mm
	With			
	Without			
	Ratchet	LXP-113R	LX-113R	LXB-113R
	Ratchet	LXP-113	LX-113	LXB-113

CLAW Grasping Forceps

	Ratchet System	Pediatric Ø3 x 220 mm	Standard Ø5 x 330 mm	Bariatric Ø5 x 450 mm
	With			
	Without			
	Ratchet	LXP-114R	LX-114R	LXB-114R
	Ratchet	LXP-114	LX-114	LXB-114

BIOPSY Forceps Double Action

	Ratchet System	Pediatric Ø3 x 220 mm	Standard Ø5 x 330 mm	Bariatric Ø5 x 450 mm
	With			
	Without			
	Ratchet	LXP-115R	LX-115R	LXB-115R
	Ratchet	LXP-115	LX-115	LXB-115

BIOPSY Forceps Single Action

	Ratchet System	Pediatric Ø3 x 220 mm	Standard Ø5 x 330 mm	Bariatric Ø5 x 450 mm
	With			
	Without			
	Ratchet	LXP-116R	LX-116R	LXB-116R
	Ratchet	LXP-116	LX-116	LXB-116



Reusable Steel Insulated Handle



MARYLAND Dissecting Forceps, Curved				
	Ratchet System	Pediatric	Standard	Bariatric
	With	Ø3 x 220 mm	Ø5 x 330 mm	Ø5 x 450 mm
	Without Ratchet			
		LXP-201	LX-201	LXB-201

MARYLAND Dissecting Forceps, Straight				
	Ratchet System	Pediatric	Standard	Bariatric
	With	Ø3 x 220 mm	Ø5 x 330 mm	Ø5 x 450 mm
	Without Ratchet			
		LXP-201S	LX-201S	LXB-201S

DOLPHIN Nose Dissecting Forceps				
	Ratchet System	Pediatric	Standard	Bariatric
	With	Ø3 x 220 mm	Ø5 x 330 mm	Ø5 x 450 mm
	Without Ratchet			
			LX-201N	LXB-201N

Dissecting Forceps, 90° Curved				
	Ratchet System	Pediatric	Standard	Bariatric
	With	Ø3 x 220 mm	Ø5 x 330 mm	Ø5 x 450 mm
	Without Ratchet			
		LXP-201D	LX-201D	LXB-201D

METZENBAUM Scissors, Curved				
	Ratchet System	Pediatric	Standard	Bariatric
	With	Ø3 x 220 mm	Ø5 x 330 mm	Ø5 x 450 mm
	Without Ratchet			
		LXP-202	LX-202	LXB-202

METZENBAUM Scissors, Straight				
	Ratchet System	Pediatric	Standard	Bariatric
	With	Ø3 x 220 mm	Ø5 x 330 mm	Ø5 x 450 mm
	Without Ratchet			
		LXP-202S	LX-202S	LXB-202S

HOOK Scissors				
	Ratchet System	Pediatric	Standard	Bariatric
	With	Ø3 x 220 mm	Ø5 x 330 mm	Ø5 x 450 mm
	Without Ratchet			
			LX-202H	LXB-202H

ENDO Grasping Forceps, Fenestrated				
	Ratchet System	Pediatric	Standard	Bariatric
	With	Ø3 x 220 mm	Ø5 x 330 mm	Ø5 x 450 mm
	Without Ratchet			
		LXP-203R	LX-203R	LXB-203R

YOHAN Grasping Forceps, Fenestrated				
	Ratchet System	Pediatric	Standard	Bariatric
	With	Ø3 x 220 mm	Ø5 x 330 mm	Ø5 x 450 mm
	Without Ratchet			
		LXP-204R	LX-204R	LXB-204R

YOHAN Grasping Forceps, Single Action				
	Ratchet System	Pediatric	Standard	Bariatric
	With	Ø3 x 220 mm	Ø5 x 330 mm	Ø5 x 450 mm
	Without Ratchet			
		LXP-205R	LX-205R	LXB-205R

YOHAN Grasping Forceps, Single Action				
	Ratchet System	Pediatric	Standard	Bariatric
	With	Ø3 x 220 mm	Ø5 x 330 mm	Ø5 x 450 mm
	Without Ratchet			
		LXP-205	LX-205	LXB-205

INTESTINAL Grasping Forceps, Fenestrated				
	Ratchet System	Pediatric	Standard	Bariatric
	With	Ø3 x 220 mm	Ø5 x 330 mm	Ø5 x 450 mm
	Without Ratchet			
		LXP-207R	LX-207R	LXB-207R

YOHAN Grasping Forceps, Single Action				
	Ratchet System	Pediatric	Standard	Bariatric
	With	Ø3 x 220 mm	Ø5 x 330 mm	Ø5 x 450 mm
	Without Ratchet			
			LX-208R	LXB-208R

YOHAN Grasping Forceps, Single Action				
	Ratchet System	Pediatric	Standard	Bariatric
	With	Ø3 x 220 mm	Ø5 x 330 mm	Ø5 x 450 mm
	Without Ratchet			
			LX-209R	LXB-209R

FUNDUS Grasping Forceps				
	Ratchet System	Pediatric	Standard	Bariatric
	With	Ø3 x 220 mm	Ø5 x 330 mm	Ø5 x 450 mm
	Without Ratchet			
			LX-210R	LXB-210R

YOHAN Grasping Forceps, Single Action				
	Ratchet System	Pediatric	Standard	Bariatric
	With	Ø3 x 220 mm	Ø5 x 330 mm	Ø5 x 450 mm
	Without Ratchet			
			LX-211R	LXB-211R

YOHAN Grasping Forceps, Single Action				
	Ratchet System	Pediatric	Standard	Bariatric
	With	Ø3 x 220 mm	Ø5 x 330 mm	Ø5 x 450 mm
	Without Ratchet			
			LX-212R	LXB-212R

BOLET Standard Grasping Forceps				
	Ratchet System	Pediatric	Standard	Bariatric
	With	Ø3 x 220 mm	Ø5 x 330 mm	Ø5 x 450 mm
	Without Ratchet			
		LXP-213R	LX-213R	LXB-213R

YOHAN Grasping Forceps, Single Action				
	Ratchet System	Pediatric	Standard	Bariatric
	With	Ø3 x 220 mm	Ø5 x 330 mm	Ø5 x 450 mm
	Without Ratchet			
			LX-214R	LXB-214R

YOHAN Grasping Forceps, Single Action				
	Ratchet System	Pediatric	Standard	Bariatric
	With	Ø3 x 220 mm	Ø5 x 330 mm	Ø5 x 450 mm
	Without Ratchet			
			LX-215R	LXB-215R

BIOPSY Forceps Single Action				
	Ratchet System	Pediatric	Standard	Bariatric
	With	Ø3 x 220 mm	Ø5 x 330 mm	Ø5 x 450 mm
	Without Ratchet			
			LX-216R	LXB-216R



### Reusable Bipolar Forceps



### Reusable Endo Scopes



### Reusable Light Guide Cable

- LX-505 Ø 4.5 X 2000 mm
- LX-506 Ø 4.5 X 2300 mm
- LX-507 Ø 4.5 X 2500 mm
- LX-508 Ø 4.5 X 3000 mm
- LX-509 Ø 4.5 X 3500 mm



### Reusable Needle Holder Advance



Pediatric Ø3 x 220 mm LXP-601	Standard Ø5 x 330 mm LX-601	Bariatric Ø5 x 450 mm LXB-601

Pediatric Ø3 x 220 mm LXP-601-2	Standard Ø5 x 330 mm LX-601-2	Bariatric Ø5 x 450 mm LXB-601-2

Pediatric Ø3 x 220 mm LXP-601-3	Standard Ø5 x 330 mm LX-601-3	Bariatric Ø5 x 450 mm LXB-601-3

Pediatric Ø3 x 220 mm LXP-601-4	Standard Ø5 x 330 mm LX-601-4	Bariatric Ø5 x 450 mm LXB-601-4

Pediatric Ø3 x 220 mm LXP-601-5	Standard Ø5 x 330 mm LX-601-5	Bariatric Ø5 x 450 mm LXB-601-5

### Reusable Needle Holder V-Type



Pediatric Ø3 x 220 mm LXP-602	Standard Ø5 x 330 mm LX-602	Bariatric Ø5 x 450 mm LXB-602

Pediatric Ø3 x 220 mm LXP-602-2	Standard Ø5 x 330 mm LX-602-2	Bariatric Ø5 x 450 mm LXB-602-2

Pediatric Ø3 x 220 mm LXP-602-3	Standard Ø5 x 330 mm LX-602-3	Bariatric Ø5 x 450 mm LXB-602-3

Pediatric Ø3 x 220 mm LXP-602-4	Standard Ø5 x 330 mm LX-602-4	Bariatric Ø5 x 450 mm LXB-602-4

Pediatric Ø3 x 220 mm LXP-602-5	Standard Ø5 x 330 mm LX-602-5	Bariatric Ø5 x 450 mm LXB-602-5

### Reusable Needle Holder Curved Handle



Pediatric Ø3 x 220 mm LXP-603	Standard Ø5 x 330 mm LX-603	Bariatric Ø5 x 450 mm LXB-603

Pediatric Ø3 x 220 mm LXP-603-2	Standard Ø5 x 330 mm LX-603-2	Bariatric Ø5 x 450 mm LXB-603-2

Pediatric Ø3 x 220 mm LXP-603-3	Standard Ø5 x 330 mm LX-603-3	Bariatric Ø5 x 450 mm LXB-603-3

Pediatric Ø3 x 220 mm LXP-603-4	Standard Ø5 x 330 mm LX-603-4	Bariatric Ø5 x 450 mm LXB-603-4

Pediatric Ø3 x 220 mm LXP-603-5	Standard Ø5 x 330 mm LX-603-5	Bariatric Ø5 x 450 mm LXB-603-5



Reusable Clip Applicator (Titanium)

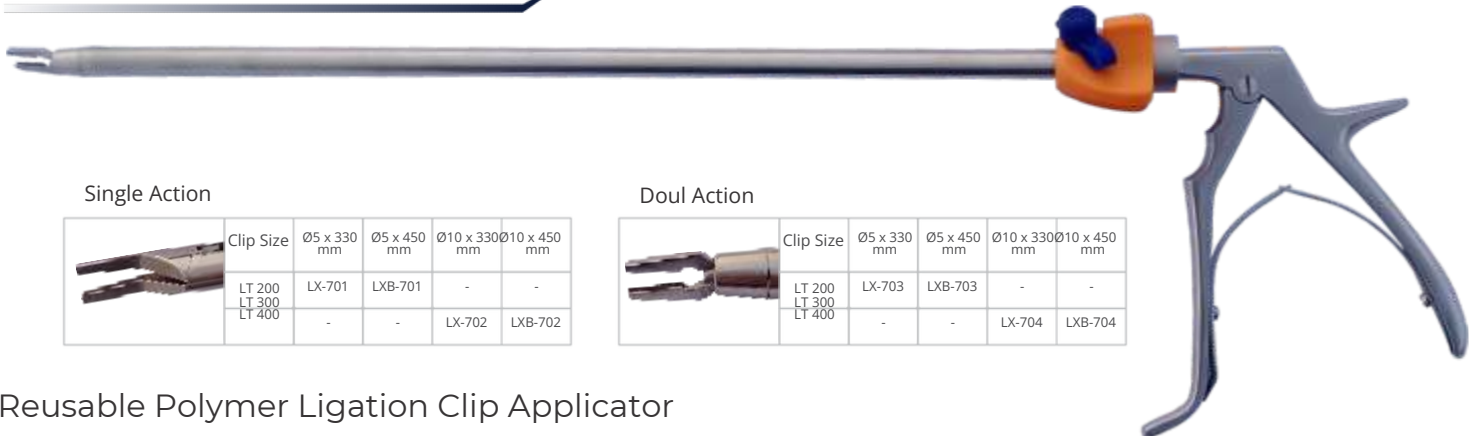

Single Action

Clip Size	Ø5 x 330 mm	Ø5 x 450 mm	Ø10 x 330 mm	Ø10 x 450 mm
LT 200	LX-701	LXB-701	-	-
LT 300	-	-	LX-702	LXB-702
LT 400	-	-	-	-

Double Action

Clip Size	Ø5 x 330 mm	Ø5 x 450 mm	Ø10 x 330 mm	Ø10 x 450 mm
LT 200	LX-703	LXB-703	-	-
LT 300	-	-	LX-704	LXB-704
LT 400	-	-	-	-

Reusable Polymer Ligation Clip Applicator



LX-705  
Large Hemo Lock Clip Applicator  
Ø10mm x 330mm



LX-706  
Medium Hemo Lock Clip Applicator  
Ø10mm x 330mm

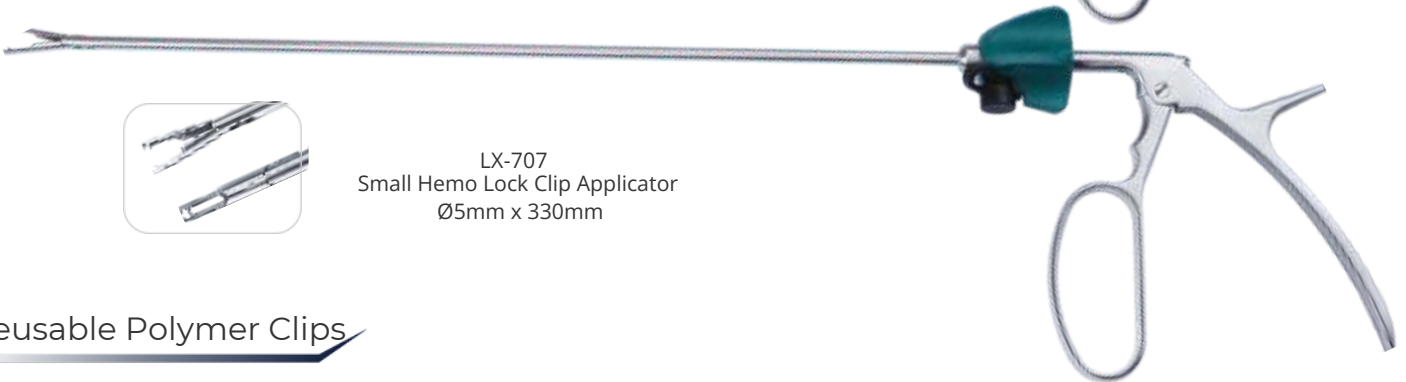

LX-707  
Small Hemo Lock Clip Applicator  
Ø5mm x 330mm

Reusable Polymer Clips



LX-705-L  
Polymer Clips Large



LX-706-M  
Polymer Clips Medium



LX-707-S  
Polymer Clips Small



### Reusable Open Surgery Clip Applicator



Clip Size	Titanium Clips	Size
LT 200	LX-708	6" & 8"
LT 300	LX-709	6" & 8"
LT 400	LX-710	6" & 8"



### Reusable Claw Forceps



LX-801  
Ø10mm x 330mm

LXB-801  
Ø10mm x 450mm

### Reusable Spoon Forceps



LX-802  
Ø10mm x 330mm

LSB-110  
Ø10mm x 450mm

### Reusable Suture Passer

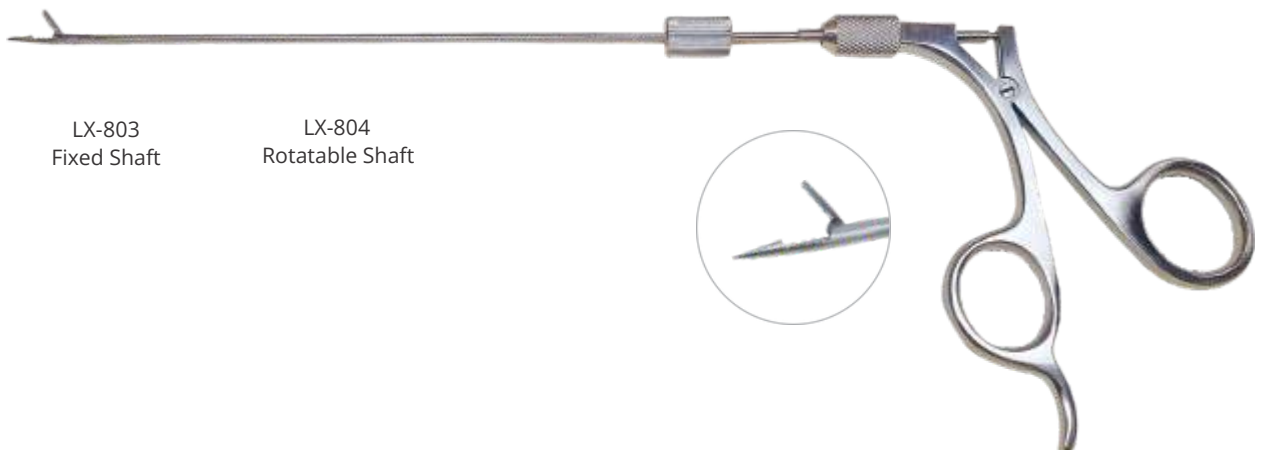

LX-803  
Fixed Shaft

LX-804  
Rotatable Shaft



Reusable Trocars

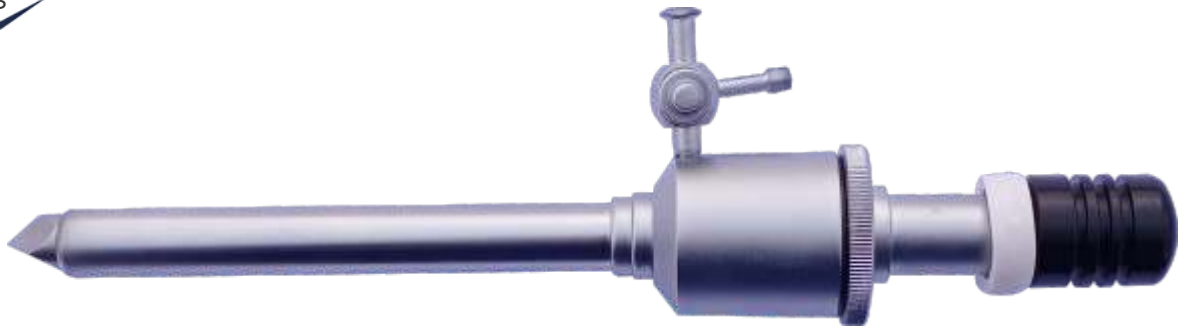

Pyramid Tip Gate wall LX-901 Ø5.5mm x 100mm LX-902 Ø10.5mm x 100mm LX-903 Ø12.5mm x 100mm LX-904 Set of 2

Pyramid Tip (Bariatric) LXB-901 Ø5.5mm x 150mm LXB-902 Ø10.5mm x 150mm LXB-903 Ø12.5mm x 150mm LXB-904 Set of 2

Reusable Trocars (Magnetic)



Trocar & Cannula Safety Shield, Magnetic LX-905 Ø5.5mm x 100mm LX-906 Ø10.5mm x 100mm LX-907 Ø12.5mm x 100mm

Reusable Trocars (Flip type)



Trocar & Cannula Pyramid Tip LX-908 Ø5.5mm x 100mm LX-909 Ø10.5mm x 100mm LX-910 Ø12.5mm x 100mm

Reusable Silicon Seals / Reducers



Silicon Seal LX-911 Ø5.5mm LX-912 Ø10.5mm



Neck Reducer LX-913 Ø10.5mm - Ø5.5mm



Sleeve Reducer LX-914 Ø10.5mm-Ø5.5mm x 50mm LX-915 Ø10.5mm-Ø5.5mm x 100mm LX-916 Ø10.5mm-Ø5.5mm x 120mm

Reusable Liver / Fan Retractor



LX-1001  
5 Prongs, Distal Articulation  
Ø5mm x 330mm

LX-1002  
5 Prongs, Distal Articulation  
Ø10mm x 330mm

Reusable Snake / Liver Retractor



LX-1003  
Positive Hook

Reusable Suction & Irrigation Thumb Control



LX-1004 Suction Irrigation with Thumb Control valves  
Interchangeable Ø5mm x 33cm, Ø10mm x 33cm cannula

Reusable Suction & Irrigation Trumpet

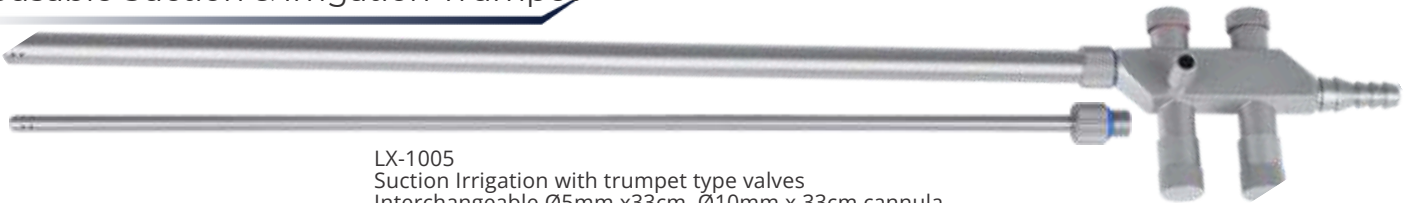

LX-1005  
Suction Irrigation with trumpet type valves  
Interchangeable Ø5mm x 33cm, Ø10mm x 33cm cannula

Reusable Suction & Irrigation Trumpet



LX-1006  
Suction Irrigation with trumpet type valves  
Interchangeable 5mm, 10mm cannula

Reusable Veress Needle



Veress Needle  
LX-1007 Ø2.5 x 100mm  
LX-1007-01 Ø2.5 x 150mm



### Reusable Electric Coagulation instruments

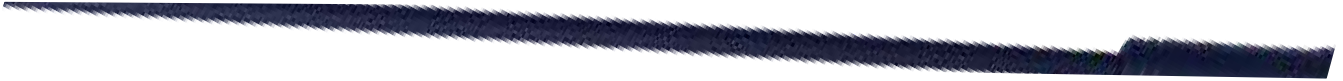

L Hook Ceramic Tip 90°  
LX-E-101 Ø5mm x 330mm  
LXB-E-101 Ø5mm x 450mm



Needle Electrode Ceramic Tip  
LX-E-102 Ø5mm x 330mm  
LXB-E-102 Ø5mm x 450mm



Spatula Electrode Ceramic  
LX-E-103 Ø5mm x 330mm  
LXB-E-103 Ø5mm x 450mm



Ball Electrode  
LX-E-104 Ø5mm x 330mm  
LXB-E-104 Ø5mm x 450mm

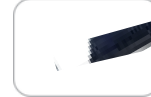

L Hook Tip 90°  
LXP-E-105 Ø3mm x 220mm  
LX-E-105 Ø5mm x 330mm  
LXB-E-105 Ø5mm x 450mm



Spetula  
LXP-E-106 Ø3mm x 220mm  
LX-E-106 Ø5mm x 330mm  
LXB-E-106 Ø5mm x 450mm

### Reusable Suction L Hook



Suction L Hook Tip 90°  
LX-E-107 Ø5mm x 330mm  
LXB-E-107 Ø5mm x 450mm

### Reusable Knot Pushers



Pencil Nose  
LX-E-108 Ø5mm x 330mm  
LXB-E-108 Ø5mm x 450mm



Open End Straight  
LX-E-109 Ø5mm x 330mm  
LXB-E-109 Ø5mm x 450mm



Eye Shaped  
LX-E-110 Ø5mm x 330mm  
LXB-E-110 Ø5mm x 450mm



Open End Curved  
LX-E-111 Ø5mm x 330mm  
LXB-E-111 Ø5mm x 450mm

### Reusable Aspiration Needle



LX-E-112  
LX-E-112 Ø5mm x 330mm  
LXB-E-112 Ø5mm x 450mm

### Reusable Myoma Screws



LX-E-113 Ø5mm x 330mm  
LXB-E-113 Ø5mm x 450mm



LX-E-114 Ø10mm x 330mm  
LXB-E-114 Ø10mm x 450mm

Aluminum Sterilization Container Box

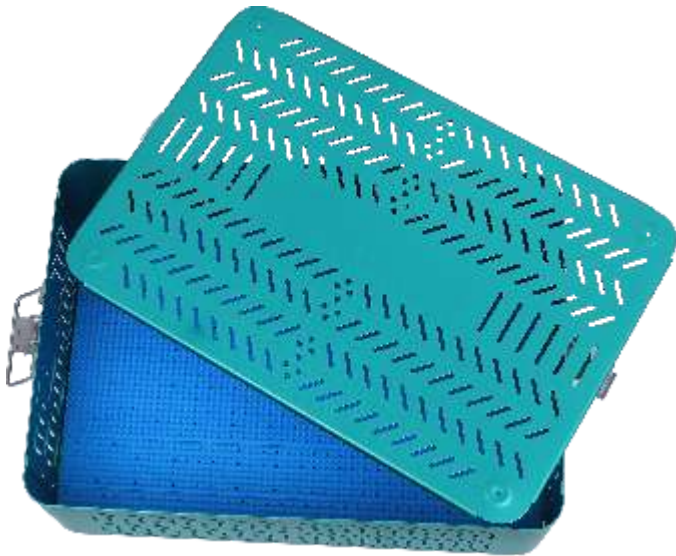

LX-AB-531  
500mm x 350mm x 150mm

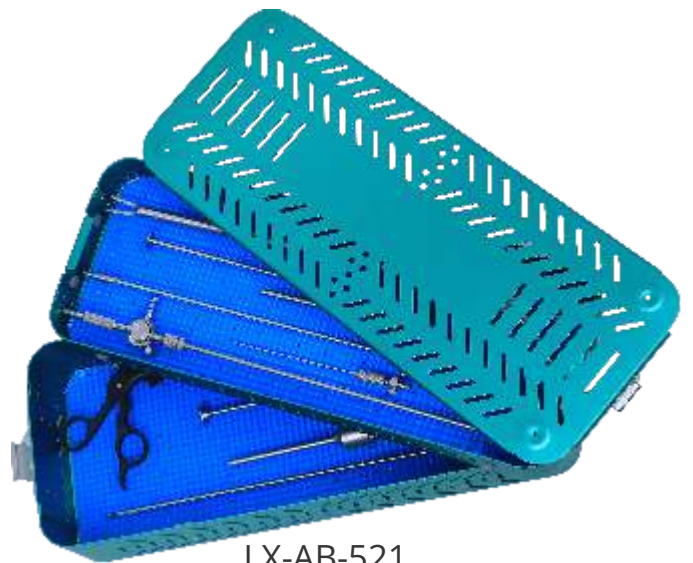

LX-AB-521  
500mm x 200mm x 100mm

Reusable Uterine Manipulator (Clemend Ferrand)



LX-100-01 Uterine Manipulator

Reusable Uterine Manipulator (HOHL Type)

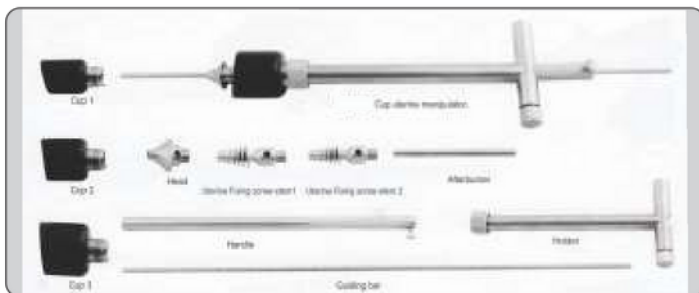

LX-100-02 HOHL Type



LX-100-03 HOHL Type

## LAPMAS Professional Laparoscopic Simulators Set (LX-PS-100)

- 👍 **LAPMAS** Training Box With Led Light.
- 👍 Navigable Hd Camera.
- 👍 9 Port Inset on Positions.
- 👍 1 Gyne Port.
- 👍 Auto/optional Recording System.
- 👍 17" Lcd With Stand.
- 👍 10 Comprehensive Training Modules.
- 👍 4 Instruments Kit.



## Instruments Kit (LX-IK-200)

- 👍 NEEDLE HOLDER Ø5mm x 33cm.
- 👍 MARYLAND Curved Ø5mm x 33cm
- 👍 Metzenbaum Scissors Curved Ø5mm x 33cm
- 👍 YOHAN Grasper Fenestrated Ø5mm x 33cm



## Training Modules (LX-PS-M100)



**Clipping Board**

LX-TM-01



**Ball Placement**

LX-TM-02



**Suturing Board**

LX-TM-03



**Suture Pad**

LX-TM-04



**Suture Pad**

LX-TM-05



**Stretch & Hang**

LX-TM-06



**Ring Passing**

LX-TM-07



**Thread Passing**

LX-TM-08



**Knot Tying**

LX-TM-09



**Peg Transfer**

LX-TM-10

## LAPRIC Portable Laparoscopic Simulators Set (LX-LS-200)

- 👍 **LAPRIC** Portable trainer.
- 👍 With OR without camera.
- 👍 7 Port Inset on Positions.
- 👍 Can be use with a smart phone and a tablet.
- 👍 Ideal for surgical residents.
- 👍 6 Comprehensive Training Modules.
- 👍 Instruments Kit.



## Training Modules (LX-LX-M200)



**Curing Board**

LX-TM-01



**Ball Placement**

LX-TM-02



**Suture Training**

LX-TM-06



**Suture Training**

LX-TM-08



**Suture Pad**

LX-TM-05

## Instruments Kit (LX-IK-200)

- 👍 NEEDLE HOLDER Ø5mm x 33cm.
- 👍 Metzenbaum Scissors Curved Ø5mm x 33cm
- 👍 MARYLAND Curved Ø5mm x 33cm
- 👍 YOHAN Grasper Fenestrated Ø5mm x 33cm

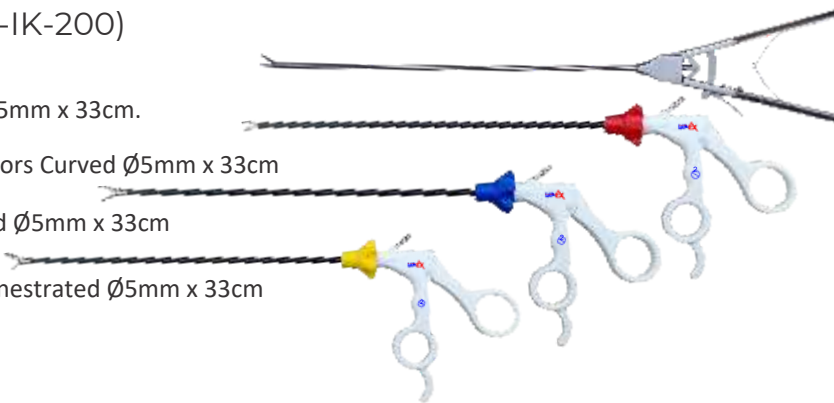

**Peg Transfer**

LX-TM-10

## SKILLMAN Open Surgery Set (LX-OS-300)

- 👍 **SKILLMAN** skill board.
- 👍 5 Work Stations .
- 👍 With 3 Suture Pads.
- 👍 3 Stations for Knot Tying.
- 👍 Instruments Kit.



**LX-OS-300B**  
Suture Pad Large

### Instrument Kit (LX-IK-201)



**LX-TM-11**  
Suture Pad Large

**LX-TM-12**  
Suture Pad Small



## *Narham Enterprises*

DESIGN, DEVELOP AND MARKET INSTRUMENTS AND ACCESSORIES FOR MINIMALLY INVASIVE SURGERY. OUR MISSION IS TO PROVIDE INNOVATIVE SOLUTIONS TO ENHANCE THE EFFICIENCY AND SAFETY OF INSTRUMENTS DESIGNED FOR VARIOUS SURGICAL PROCEDURES.



[www.narhamenterprises.com](http://www.narhamenterprises.com)

SHOP ONLINE LAPAROSCOPIC & SURGICAL PRODUCTS

**Narham enterprises**  
**Head Office Shahabpura Sialkot**



[narhamenterprises@gmail.com](mailto:narhamenterprises@gmail.com)



[www.Narhamenterprises.com](http://www.Narhamenterprises.com)



03700048270