

CHISELS AND GOUGES

Chisels and gouges are essential instruments for cutting, shaping, and contouring bone in orthopedic surgery. Chisels provide clean, straight cuts, while gouges are ideal for scooping or carving curved surfaces. Crafted from high-quality surgical steel, our instruments ensure sharpness, durability, and precise control for efficient bone work with minimal tissue disruption.



CHISELS

ALEXANDER CHISELS

7-1/8" (18 cm).

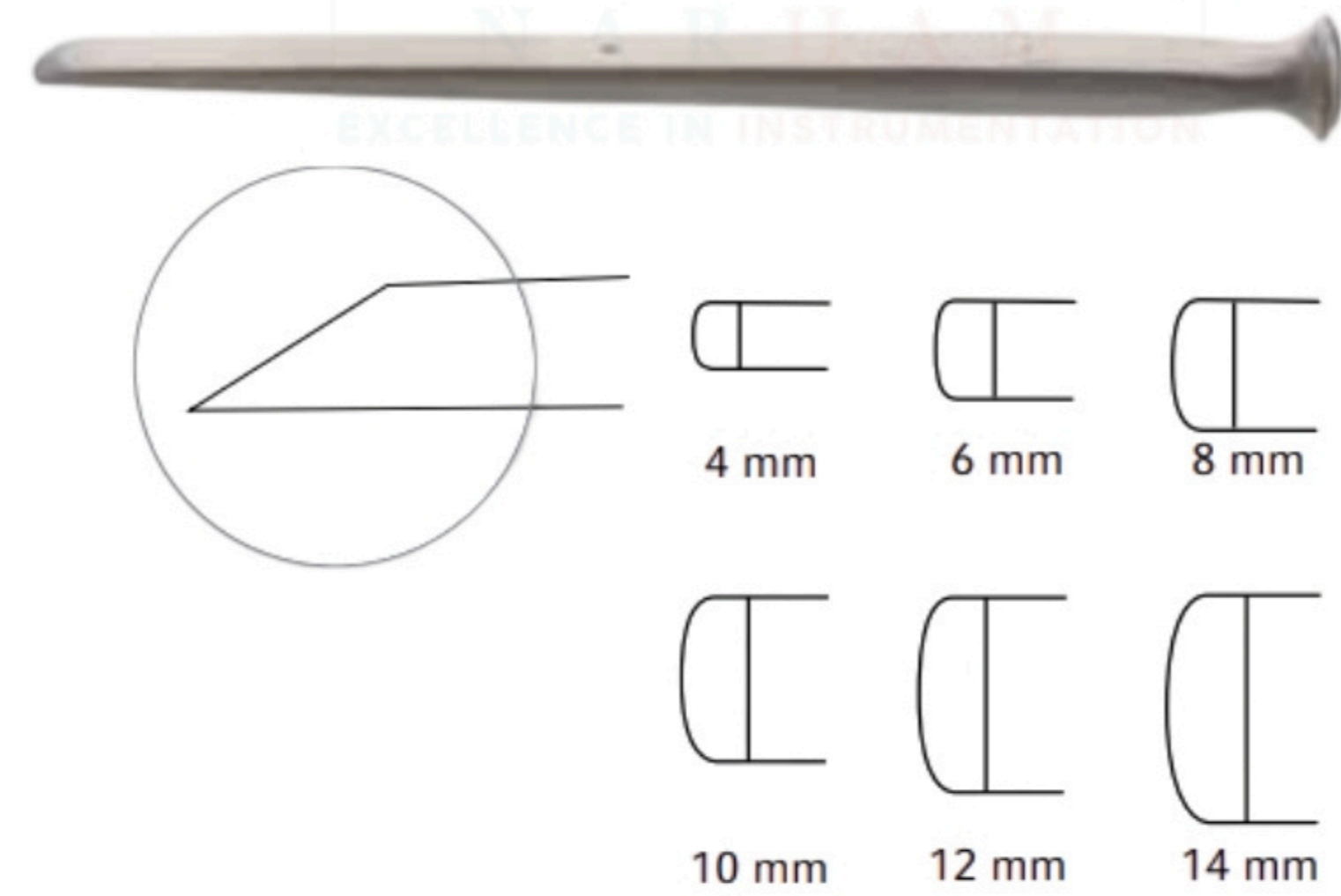

CODE #	DESCRIPTION
NE49040	4 mm
NE49041	6 mm
NE49042	8 mm
NE49043	10 mm
NE49044	12 mm
NE49045	14 mm

ARMY PATTERN CHISELS

7-1/8" (18 cm).

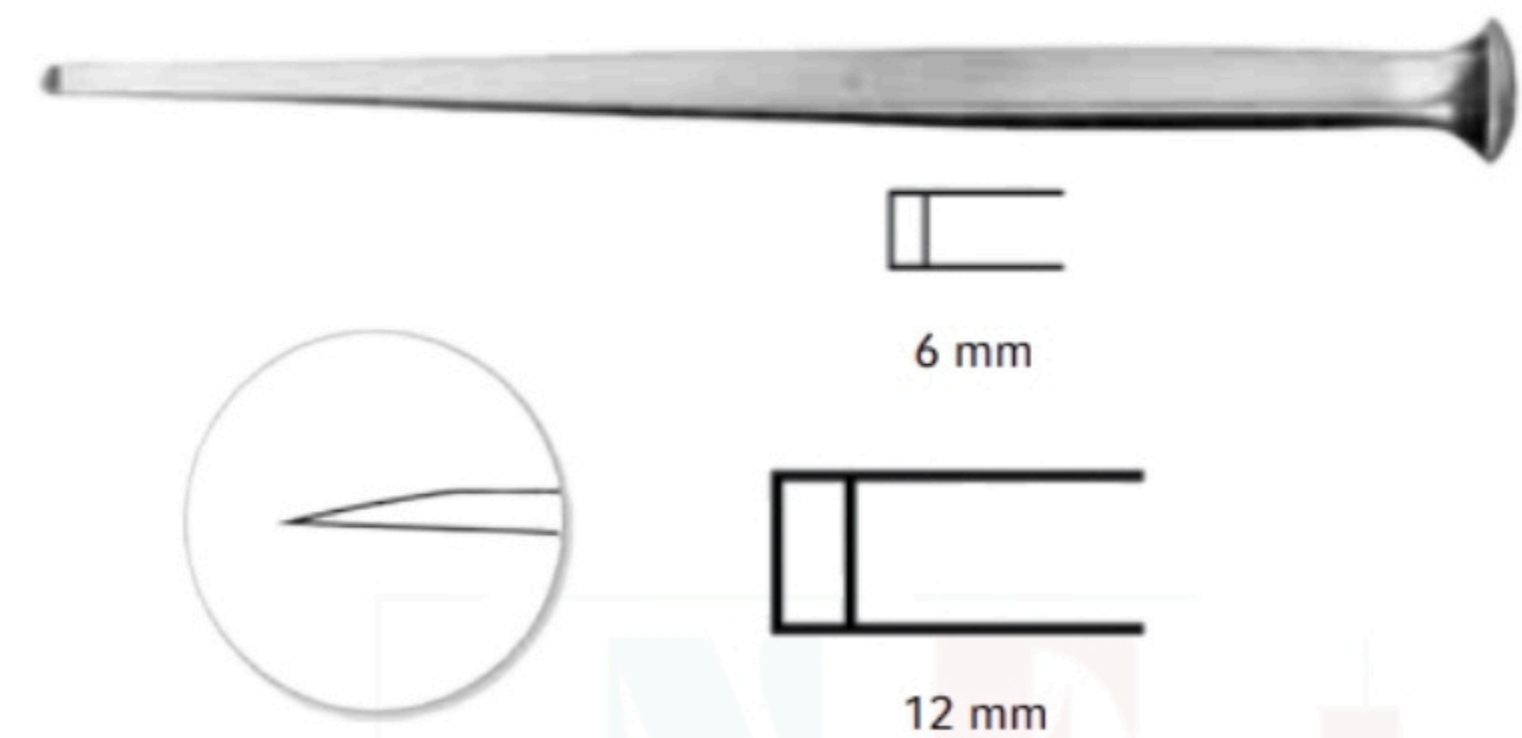

CODE #	DESCRIPTION
NE46289	6 mm
NE46290	12 mm
NE46291	18 mm

HOKE CHISELS

Straight, 5-1/4" (13.5 cm).

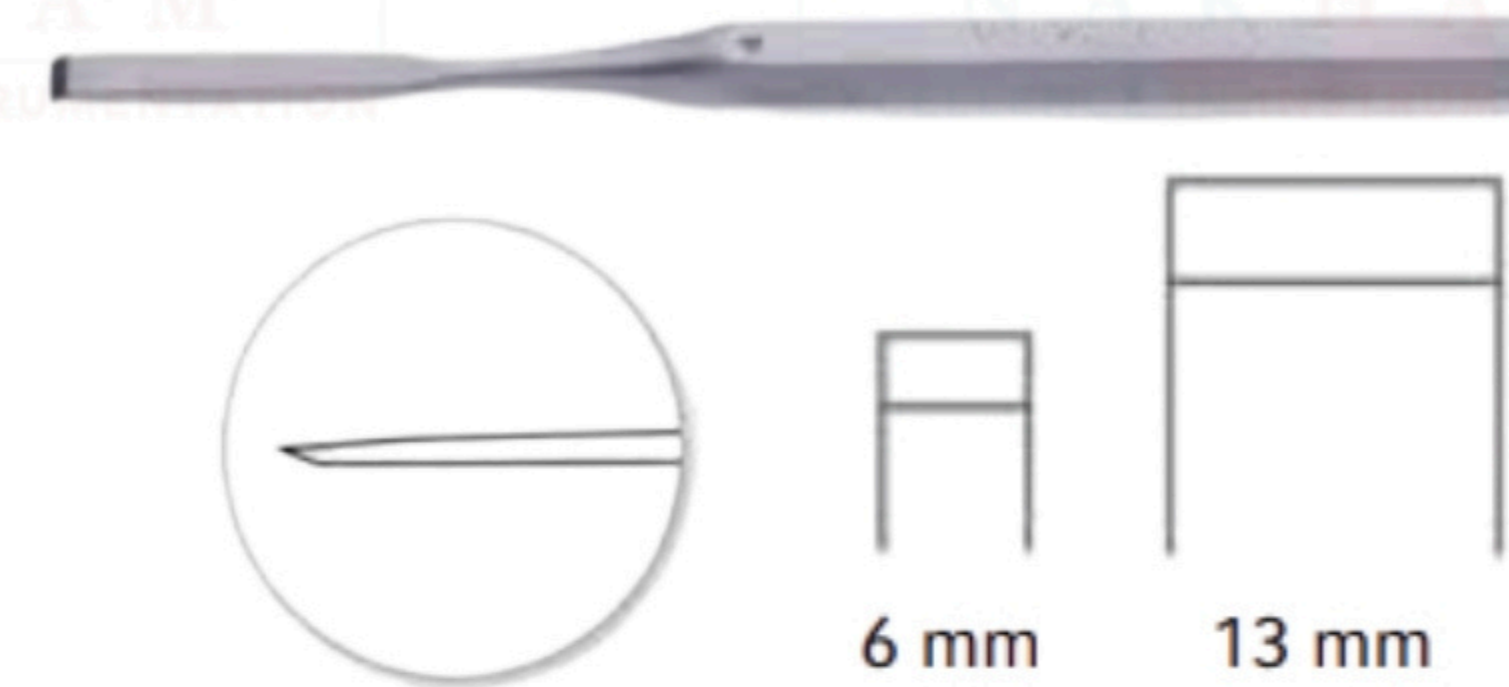

CODE #	DESCRIPTION
NE46505	3/16" (4 mm)
NE46506	1/4" (6 mm)
NE46507	3/8" (10 mm)
NE46508	1/2" (13 mm)
NE46509	3/4" (19 mm)

HIBBS CHISELS

9" (23 cm).

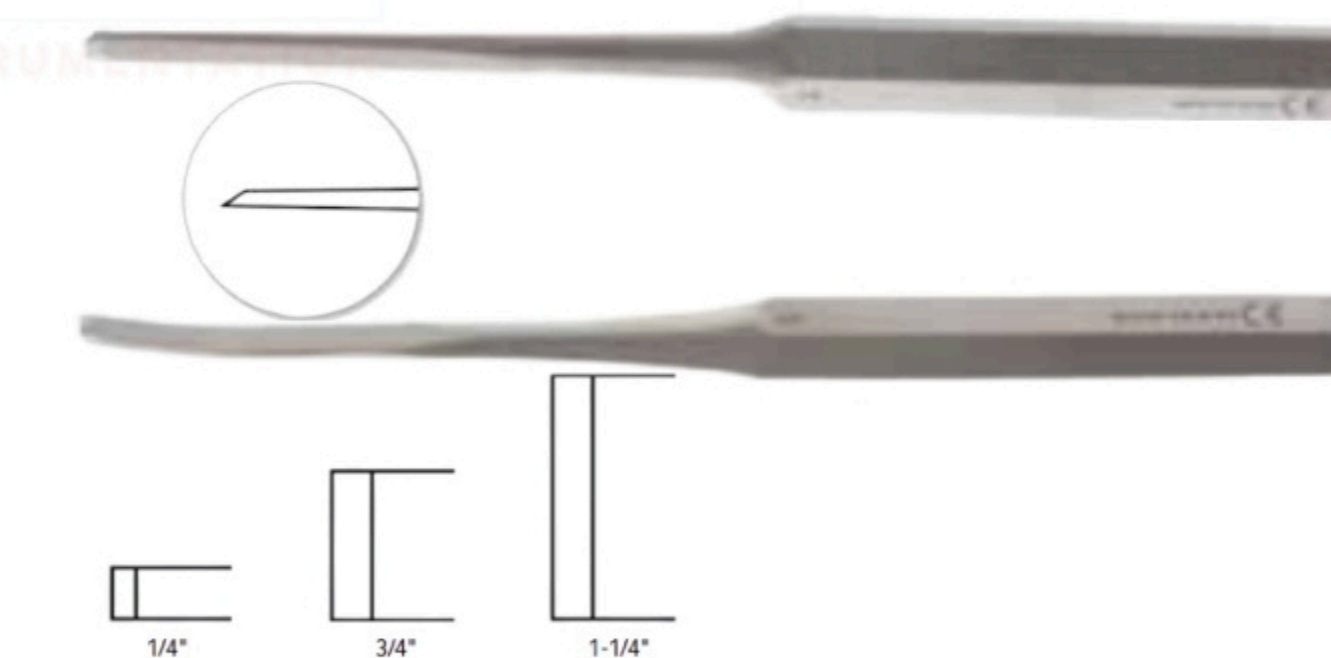

CODE #	tip	TIP WIDTH	CODE #	tip	TIP WIDTH
NE49073	Curved	1/4"	NE49059	Straight	1/4"
NE49074	Curved	3/8"	NE49060	Straight	3/8"
NE49075	Curved	1/2"	NE49061	Straight	1/2"
NE49076	Curved	5/8"	NE49062	Straight	5/8"
NE49077	Curved	3/4"	NE49063	Straight	3/4"
NE49078	Curved	1"	NE49064	Straight	1"
NE49081	Curved	1-1/4"	NE49065	Straight	1-1/4"
NE49082	Curved	1-1/2"	NE49066	Straight	1-1/2"

LEXER CHISELS

Phenolic handle, 8-5/8" (22 cm).

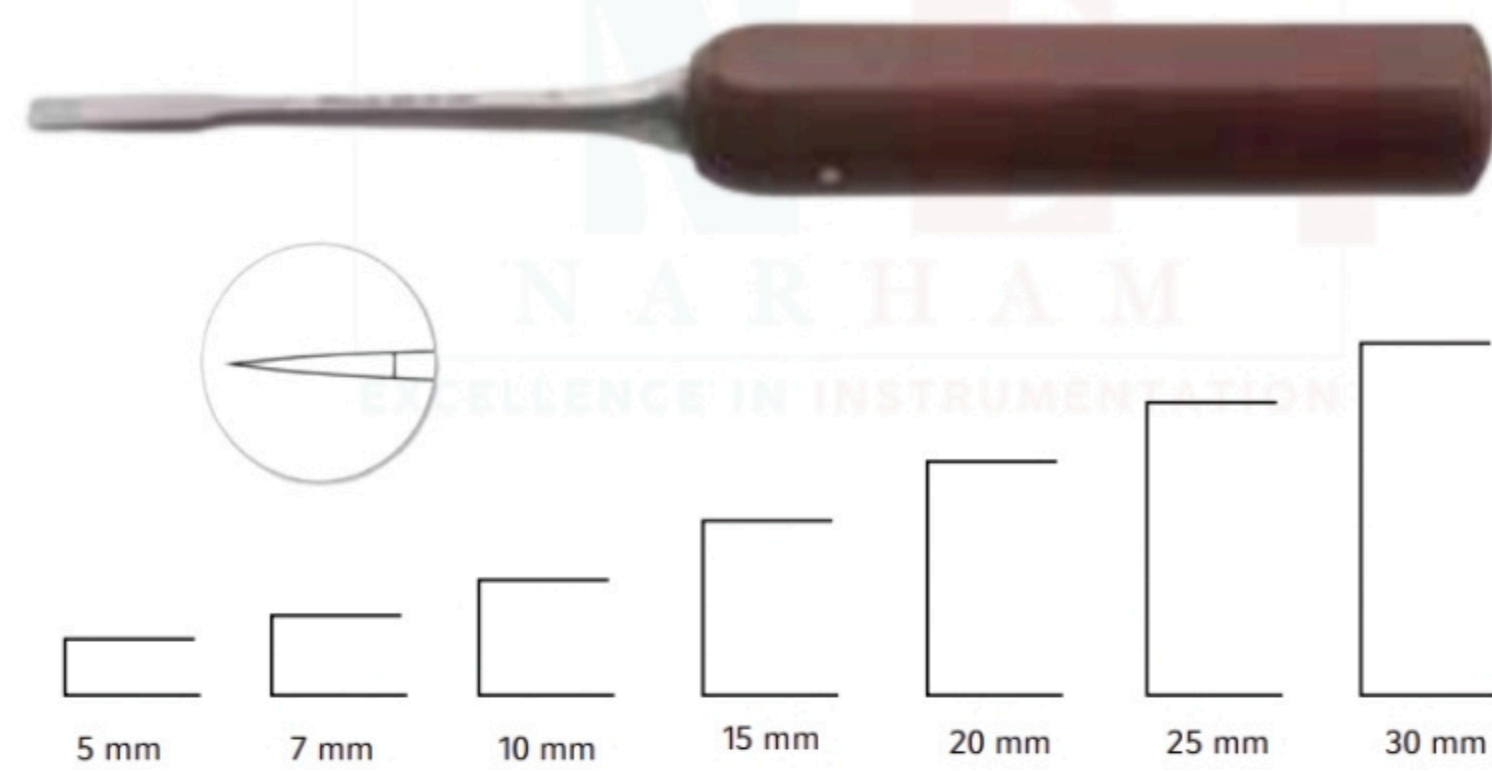

CODE #	DESCRIPTION
NE49246	5 mm
NE49248	7 mm
NE49250	10 mm
NE49252	15 mm
NE49254	20 mm
NE49256	25 mm
NE49258	30 mm

LEXER MINI CHISELS

Phenolic handle, 7-1/8" (18 cm).

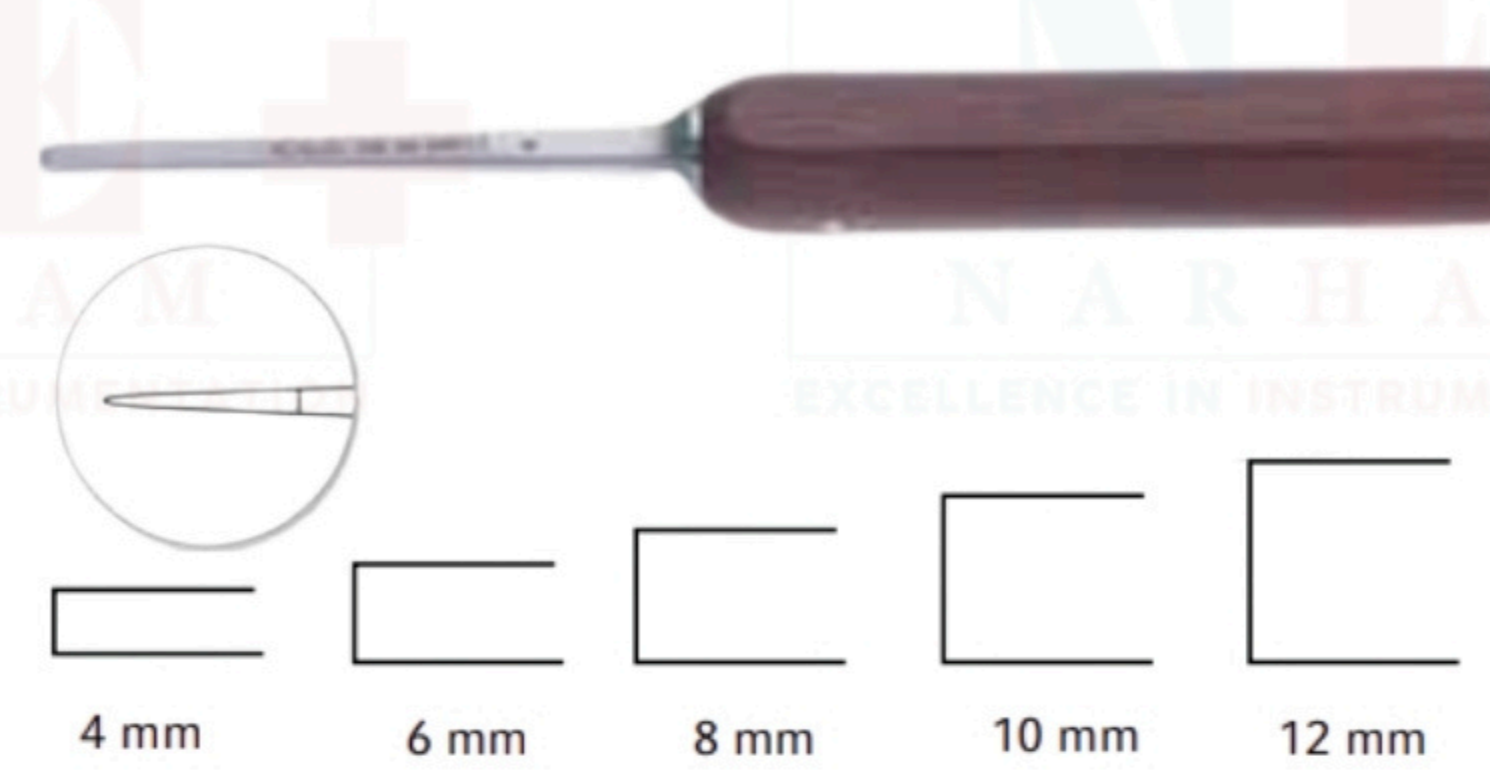

CODE #	DESCRIPTION
NE49260	4 mm
NE49262	6 mm
NE49264	8 mm
NE49266	10 mm
NE49268	12 mm

STILLE-TYPE CHISELS

8-1/8" (20.5 cm)

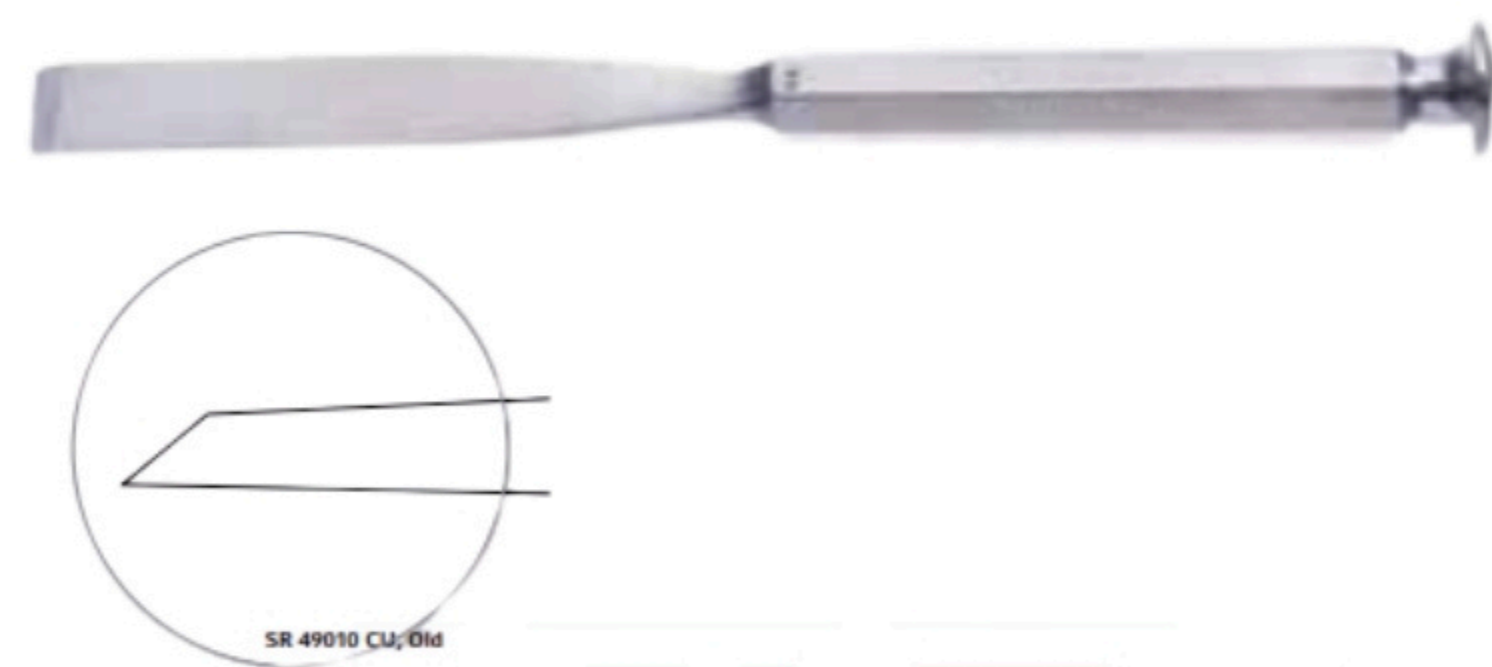

CODE #	DESCRIPTION
NE49010	10 mm
NE49012	14 mm
NE49014	18 mm
NE49016	22 mm

GOUGES

ALEXANDER GOUGES

7" (18 cm).

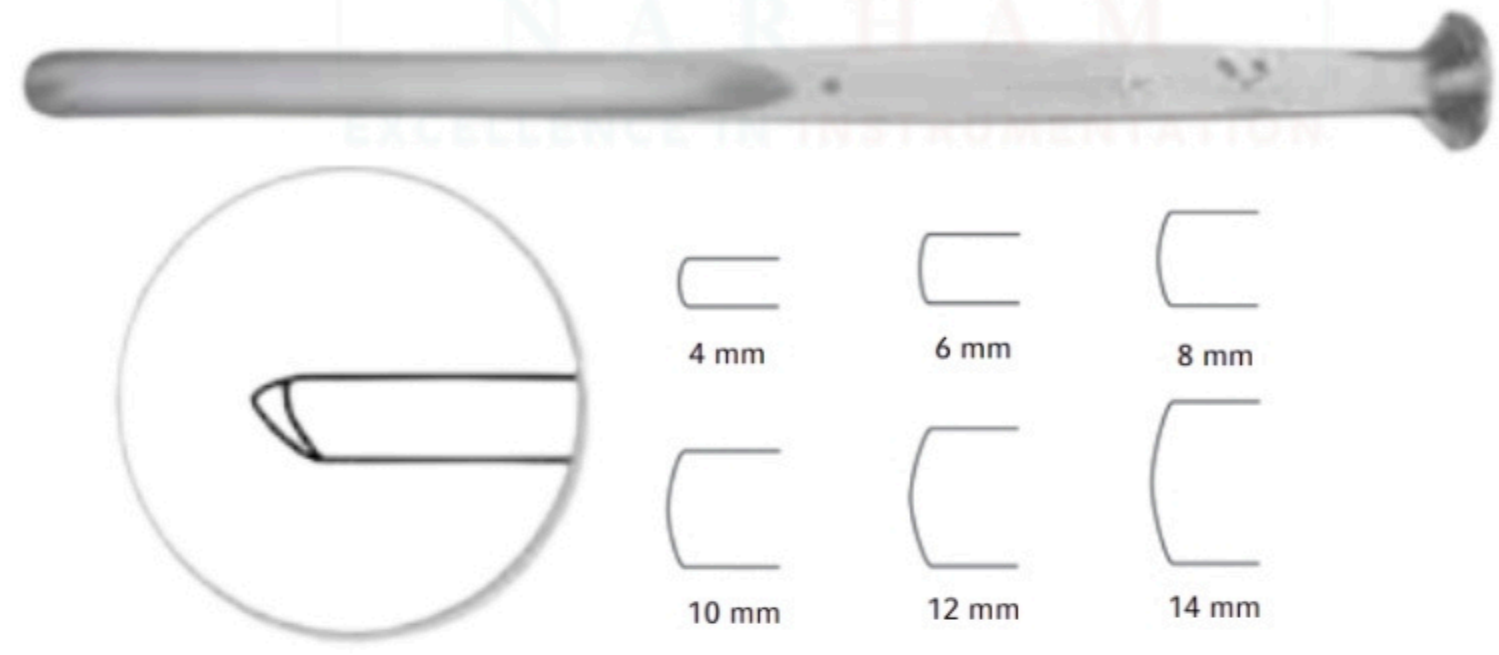

CODE #	DESCRIPTION
NE49050	4 mm
NE49051	6 mm
NE49052	8 mm
NE49053	10 mm
NE49054	12 mm
NE49055	14 mm

STILLE-TYPE GOUGES

8" (20.5 cm).

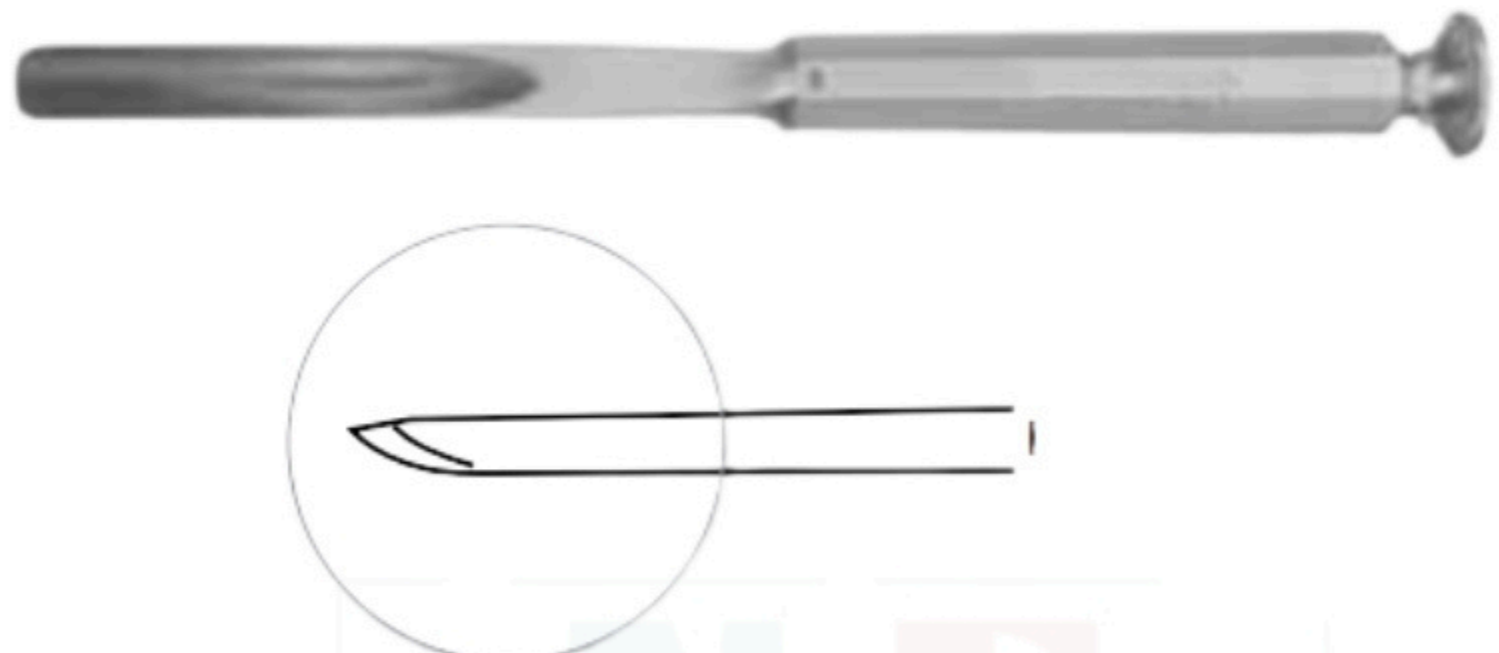

CODE #	DESCRIPTION
NE49018	10 mm
NE49020	14 mm
NE49022	18 mm
NE49024	22 mm

U.S. ARMY PATTERN GOUGES

7" (18 cm).

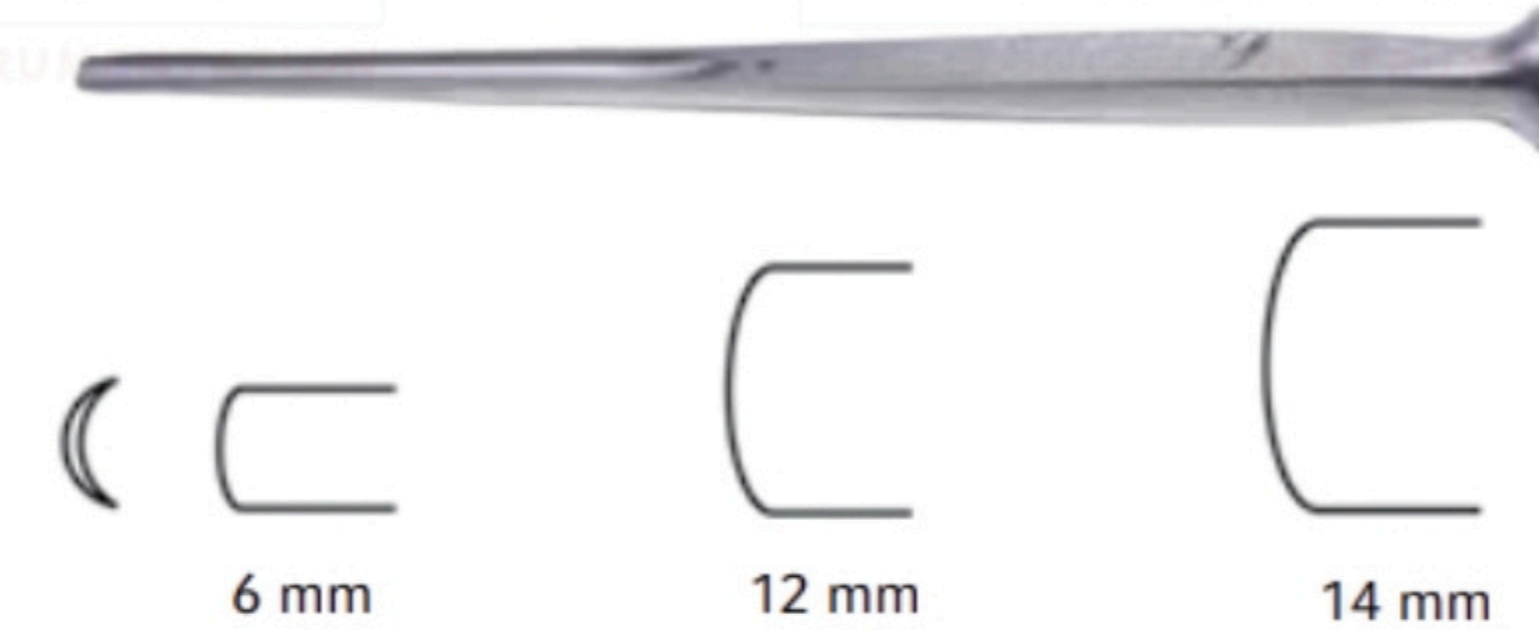

CODE #	DESCRIPTION
NE46292	6 mm
NE46293	12 mm
NE46294	14 mm

SHOULDER PENETRATING GOUGE



CODE #	DESCRIPTION
NE46919	3 mm tip, 8-1/2" (21.5 cm)

SWAN NECK GOUGE

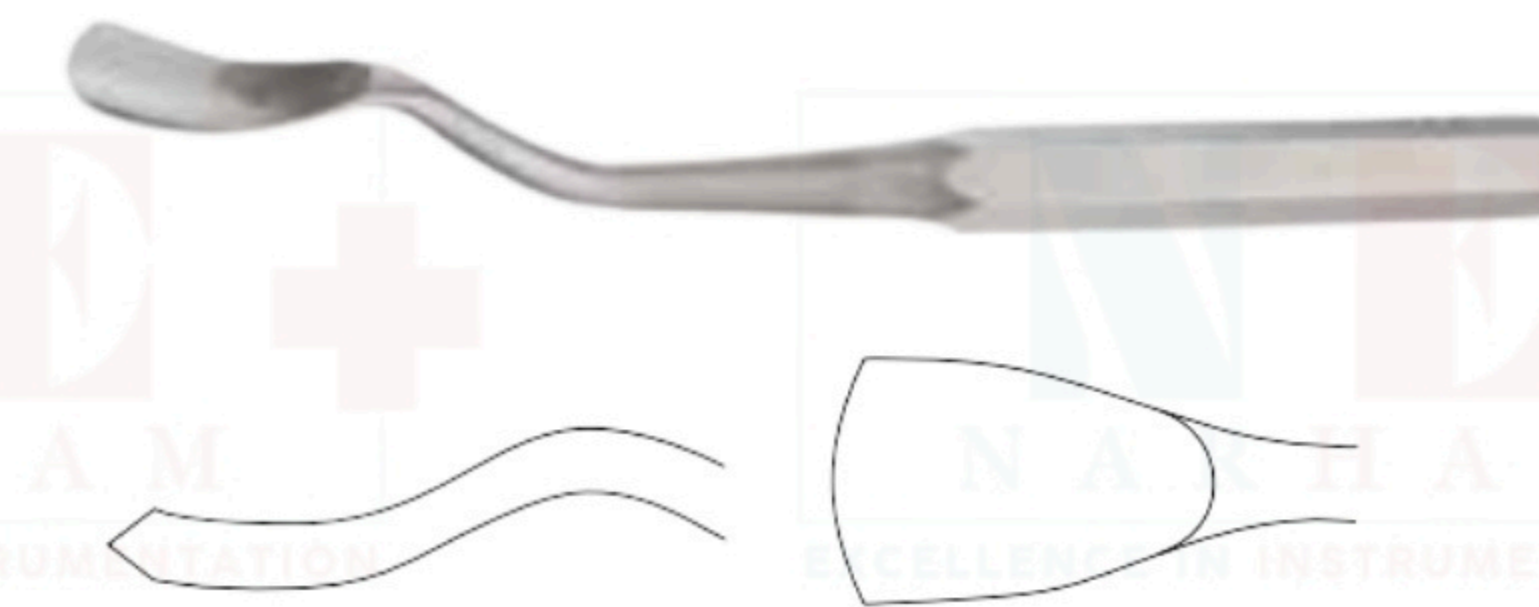

CODE #	DESCRIPTION
NE49084	1" distal tip, 9" (23 cm)

SMITH PETERSON GOUGES

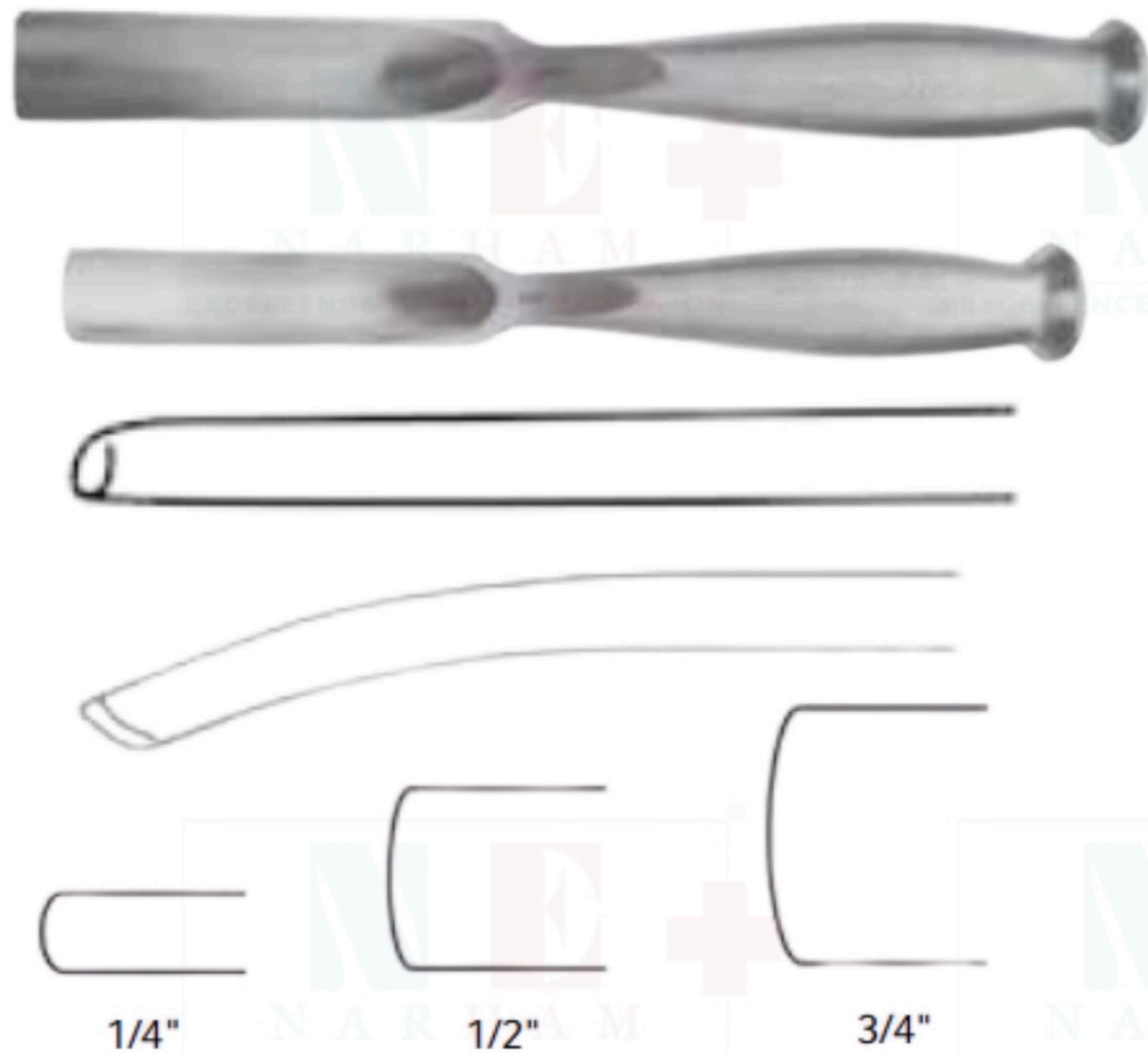

CODE #	tip	TIP WIDTH
KM46466	Straight	1/4"
KM46467	Straight	3/8"
KM46468	Straight	1/2"
KM46476	Straight	5/8"
KM46477	Straight	3/4"
KM46478	Straight	1"
KM46479	Straight	1-1/4"
KM46487	Curved	1/4"
KM46488	Curved	3/8"
KM46489	Curved	1/2"
KM46490	Curved	5/8"
KM46491	Curved	3/4"
KM46493	Curved	1"
KM46495	Curved	1-1/4"

HIBBS GOUGES

9" (23 cm).

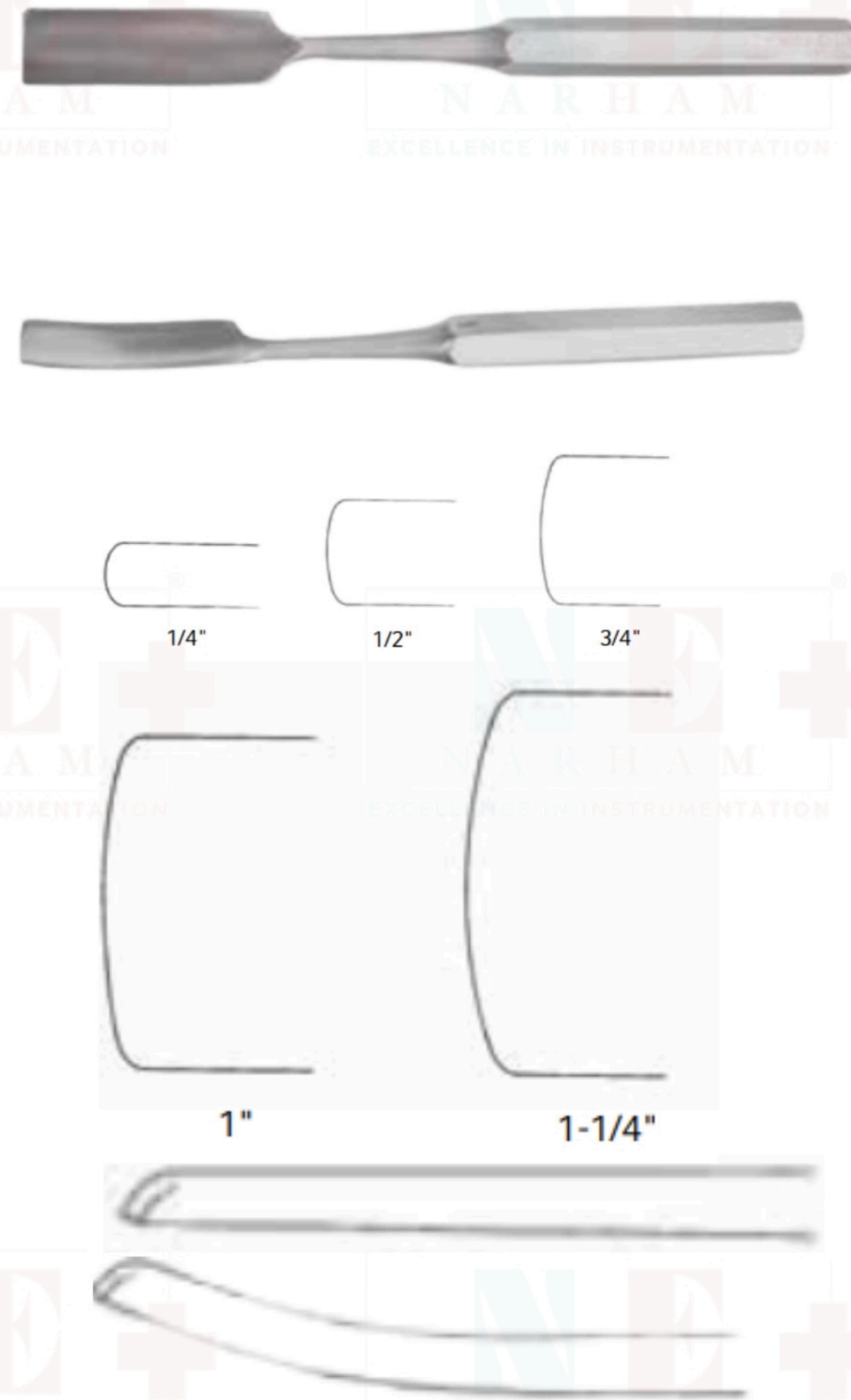

CODE #	tip	TIP WIDTH
KM46387	Straight	1/4"
KM46388	Straight	3/8"
KM46389	Straight	1/2"
KM46390	Straight	5/8"
KM46391	Straight	3/4"
KM46392	Straight	1"
KM46395	Straight	1-1/4"
KM46401	Straight	1-1/2"
KM46402	Curved	1/4"
KM46403	Curved	3/8"
KM46404	Curved	1/2"
KM46405	Curved	5/8"
KM46407	Curved	3/4"
KM46409	Curved	1"
KM46411	Curved	1-1/4"
KM46412	Curved	1-1/2"

HIBBS ENDOSCOPIC GOUGE

Straight tip, stainless steel handle, 18-1/2" (47 cm).

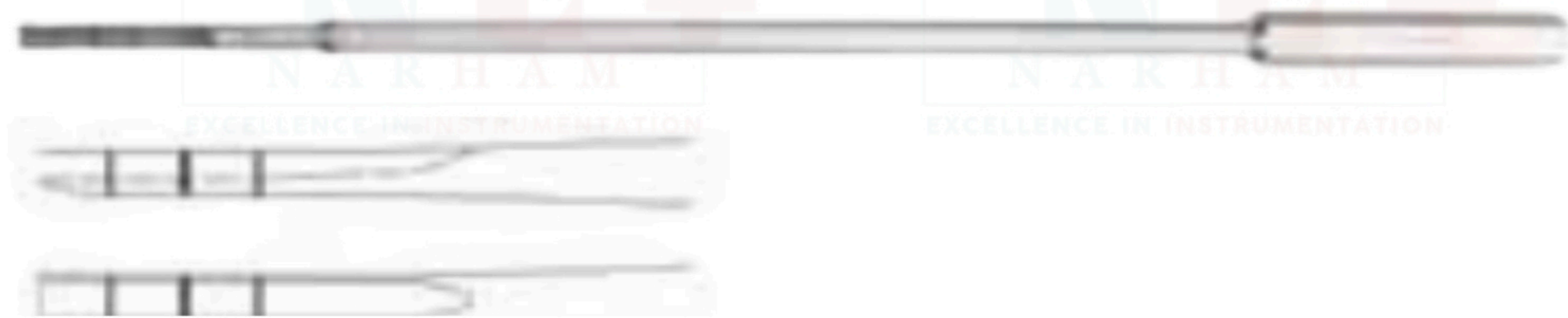

CODE #	TIP WIDTH	TIP LENGTH	SHAFT LENGTH	SHAFT DIAMETER	HANDLE LENGTH
NE55630	0.28" (7 mm)	3-1/2"	10-3/4"	0.43"	4-1/4"

COBB-TYPE SPINAL GOUGES

All stainless, with knurled handle, 5/32" (7 mm) distal tip, 11" (28 cm).

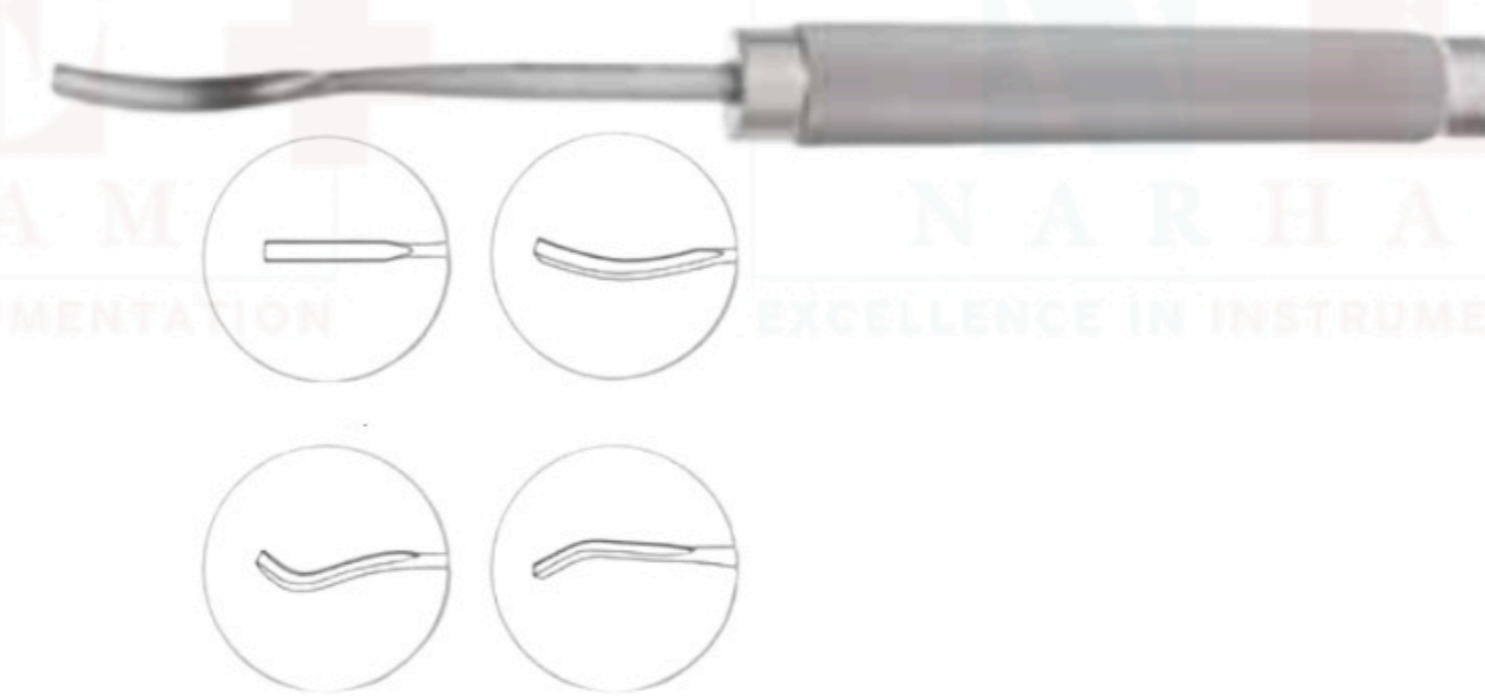

CODE #	DESCRIPTION
NE49030	Straight
NE49032	Medium curve
NE49034	Strong curve
NE49036	Reverse curve